

**X30**

**OPERATING MANUAL**

[spinogy.de](https://spinogy.de)

# Index

## Preamble

### **01 General remarks** **7**

01.1 Notice	7
01.2 Limitation of liability	7
01.3 Product name and type designation	7
01.4 Labeling of the spindle	7
01.5 Manufacturer details	8
01.6 Target group	8
01.7 Lifecycles of the machine	8

### **02 Safety instructions** **9**

02.1 Contractual use	9
02.2 Symbols and notes	9
02.3 Personnel requisition	10
02.4 Responsibilities and duties of the operator	11
02.5 Modifications and unauthorized changes	11
02.6 Special hazard warnings	12

### **03 Transport, packaging and storage** **13**

03.1 Transport	13
03.2 Packaging	13
03.3 Storage	13

### **04 Technical description** **14**

04.1 Configuration possibilities and technical data	14
04.2 Dimensions	19
04.3 Cooling	28
04.4 Tool interfaces	29
04.5 Motor characteristics	30
04.6 Heat detector	38
04.7 Rotation sensor	39
04.8 Clamping position and piston position sensor	41
04.9 Labyrinth seal	41

<b>05 Installation</b>	<b>42</b>
05.1 Transport damages check	42
05.2 Completeness check	42
05.3 Install spindle	42
05.4 Assembly of the spindle	43
05.5 Pin allocations	44
05.6 Coolant connections	47
05.7 Pneumatic relay	48
<b>06 Commissioning</b>	<b>49</b>
06.1 Commissioning for regular use	49
06.2 Warm-up run and grease distribution run	49
06.3 Manual tool change	51
06.4 Semi-automatic tool change	52
06.5 Automatic tool change	54
06.6 Monitoring of the tool clamping system	55
<b>07 Maintenance</b>	<b>56</b>
07.1 Spindle bearings	56
07.2 Maintenance after initial commissioning	56
07.3 Daily cleaning	56
07.4 Monthly maintenance	56
07.5 Re-lubricate HSK- and SK-clamp	56
07.6 Cleaning of the filter mat	57
07.7 Maintenance and spare parts	57
<b>08 Disassembly and disposal</b>	<b>58</b>
08.1 Disassembly	58
08.2 Disposal	59
<b>09 Service and repair</b>	<b>60</b>
09.1 Service and repair authorized users	60
09.2 Troubleshooting	60
<b>10 Warranty</b>	<b>63</b>
<b>11 Declaration of installation</b>	<b>64</b>



# Preamble

Dear customer,

Thank you for choosing a spindle from SPINOGY!

With the X30 we have developed a product that provides you a construction kit allowing you to configure a spindle exactly and exclusively aligning to your individual technical requirements. Thereby, we can offer you a highly qualitative product made in Germany at favourable conditions. Furthermore, the construction kit allows us, if required, that the spindle can be modified to another spindle configuration later.

The single components of the spindles are manufactured with our machines, assembled in Weiterstadt and completed with high-quality purchased parts. So we can monitor the complete manufacturing process and always ensure a high quality. In order to keep the quality for a long period, please carefully read this operating manual.

SPINOGY is always working on further development of our products. Therefore, deviations may occur with the spindle and the operating manual. We therefore ask you for your understanding, that no claims can be derived from technical data, illustrations or descriptions.

During the development of the spindle, we have always taken care to involve the feedback of our customers. Nevertheless, we always want to improve to be able to respond to requests even more specific. Therefore, we are very grateful for your praise, constructive criticism and suggestions.

Please contact us for any request, questions or wishes about our products or your application case. We are glad to help you. Just use our contact form on our homepage or contact us via E-mail: [mail@spinogy.de](mailto:mail@spinogy.de). Of course, we are also available for a personal conversation.

We wish you a successful work with the X30.

Marcel Linke, Andreas Schleifer, Dominik Eschenbach and Marc Schmidt-Winterstein  
Managing directors SPINOGY



# 01 General remarks

## 01.1 Notice

This operating manual contains important information about handling the product. It has to be read carefully before use. The SPINOGY X30 may only be put into operation if the operating manual was understood completely. If there are obscurities, SPINOGY must be contacted. Please follow the instructions of this operating manual. This operating manual must be available for the user at any time and must be replaced in case of loss or impracticality immediately. The obligation to retain applies as long as someone is in possession of the product.

The content of this operating manual is checked for conformity with the described incomplete machine, but deviations and mistakes cannot be excluded. Technical and content-related changes, errors and misprints are reserved.

This operating manual is subject to the copyright law and may not be reproduced, copied or changed in any form, neither all nor part, without the permission of the author.

In case of contravention, there is a risk of criminal prosecution. All rights reserved.

## 01.2 Limitation of liability

SPINOGY doesn't assume liability for personal injuries, material damages, damages caused to the device and consequential damages caused by failure to follow this operating manual, improper use of the device, repairs or any other actions done by non-qualified workers (See chapter 2.3 - Personal requisition) damages on this unit occur or occurred by using unauthorized non-approved spare parts. Non-compliance of maintenance intervals and maintenance specification of the manufacturer does also lead to limitation of liability (Please see chapter 7 - Maintenance). In addition, it is strictly prohibited to make any unauthorized modifications or technical changes on the device.

## 01.3 Product name and type designation

This operating manual is intended for the spindles of the following type:

<b>Product name:</b>	X30
<b>Configuration number:</b>	Labeling with XP***
<b>Option number:</b>	Labeling with CG***

## 01.4 Labeling of the spindle



The spindle is labeled with a six-digit serial number and a five-digit item number. The data is located on the right side of the spindle, pursuant to the following picture. On the back of the spindle is the type plate with all the necessary data for control.

Using this serial number, all necessary information can be obtained from SPINOGY at any time.

## 01.5 Manufacturer details

<b>Name:</b>	SPINOGY GmbH
<b>Address:</b>	Brunnenweg 17, 64331 Weiterstadt
<b>E-Mail:</b>	mail@spinogy.de
<b>Phone:</b>	+49 6150 / 970 960
<b>Website:</b>	spinogy.de

## 01.6 Target group

This operating manual is primarily aimed to the following staff:

- Installation staff
- Machine operators
- Maintenance staff

## 01.7 Lifecycles of the machine

The machine processes the following lifecycles:

- Transport
- Assembly
- Operation
- Maintenance
- Disassembly
- Disposal



# 02 Safety instructions

## 02.1 Contractual use

SPINOGY X30 is to be considered as an incomplete machine for the installation into machine tools, covered by the definition of a fixed industrial large tool.

Seen in isolation, the spindle cannot fulfill any function. The installation has to be done by the manufacturer of the machine tool, as the required skills for professional installation cannot be expected from end users. The spindle may only be put into operation after it has been properly fastened.

Within the machine tool, materials as metal, wood, plastic or composite materials can be processed. If other materials are processed, SPINOGY needs to be contacted. For the proper use of the spindles, suitable tools must be used.

## 02.2 Symbols and notes

The mentioned symbols in this operating manual shall obviously call the attention of the reader to potential dangers. Those indications or warnings can never be seen as a replacement for correct accident prevention!



**Warning of general hazard**



**Warning of dangerous electrical voltage**



**Warning of hot surface**



**Note to avoid material damage**

The following signal words are used:

SIGNAL WORD	MEANING
<b>DANGER</b>	Danger with a high risk-level that will result in death or serious injury in case of non-observance.
<b>WARNING</b>	Danger with a medium risk-level that will result in death or serious injury in case of non-observance.
<b>CAUTION</b>	Danger with a low risk-level that will result in minor or moderate injury in case of non-observance.
<b>NOTE</b>	Information that may lead to material damage in case of non-observance.

## 02.3 Personnel requisition

### Basic details

Only persons who can be expected to perform their work reliably are permitted as personnel. Persons who have an affected capacity of reaction, e.g. through drugs, alcohol, or medication, are not permitted. Adhere to the valid local regulations relating to age and profession when selecting staff.



#### **WARNING: Improper use**

Improper use of the product can lead to considerable personal injuries and material damage. All activities may only be carried out by qualified and trained personnel. If the personnel doesn't have the necessary expertise, the personnel is to be trained and instructed.

### Qualification

The tasks described in this operating manual represent different personal and professional requirements for the qualifications of the people who are entrusted with these tasks. In this operating manual, the following qualifications are therefore named and required for various fields of activity:

#### **1. Professionals**

Professionals are, due to their technical training, knowledge and experience and their knowledge of the relevant standards and regulations, able to evaluate and carry out the given tasks. Furthermore, they are able to recognize and avoid potential dangers independently.

#### **2. Electricians**

Electricians are, due to their technical training, knowledge and experience and their knowledge of the relevant standards and regulations, able to evaluate and carry out the given tasks. Furthermore, they are able to recognize and avoid potential dangers independently. These electrical engineering works are only allowed, however, to be performed by electricians or under their direction and monitoring.

The technical requirements for electricians are:

- Technical education (Electrical engineering)
- Knowledge and experience in the respective field of activity
- Knowledge of the relevant standards
- Evaluation of the work assigned to them
- Recognizing hazards

#### **3. Instructed staff**

Instructed staff are employees who can behave safely at their workplace. For this purpose, they must be informed about the possible hazards resulting from the tasks assigned to them. In addition, they should recognize the purpose of the occupational safety and health measures and assume personal responsibility for their health-conscious behavior.

For this purpose, they must be informed by the operator about the tasks assigned to them and possible hazards resulting from improper behavior. Corresponding effectiveness-checks by the operator are recommended.

Note: Staff must be regularly and sufficiently instructed by the operator. Further details are regulated in the national occupational safety laws and regulations. For better traceability, the execution of the instruction must be recorded.

**WARNING: Unauthorized staff**

Unauthorized staff is unaware of the hazards in their work area. Failure to comply with the personnel requirement can result in serious injury or even death.

**Unauthorized staff**

Any person who:

- has not read this operating manual, has not read it completely or has not clearly understood it
- does not meet the qualification requirements for working at the SPINOGY X30 spindle
- has not received instructions from the operator for working at the spindle

is considered an unauthorized person.

The following points must therefore be observed in any case:

- Keep unauthorized persons away from the danger and work area
- In case of doubt, talk to persons and direct them away from the danger and working area
- Interrupt the work as long as unauthorized persons are in the danger and work area
- Deny access to unauthorized people

## 02.4 Responsibilities and duties of the operator

The operator himself is assumed to have the necessary qualifications and special expertise in handling machine tools and systems. If the operator does not carry out the necessary work himself, appropriate personnel must be called in for the professional installation, commissioning, maintenance and repair, dismantling/ decommissioning/ disposal!

In addition to the safety instructions in this manual, the country-specific safety measures, occupational health and safety measures and environmental protection regulations etc. valid for the application range of the machine must be observed.

Furthermore, the operator is responsible for the following points:

- Ensuring that the spindle is always in a technically perfect condition
- Compliance with maintenance intervals
- Creating of operating manuals
- Creating of hazard assessments
- Training and instruction of authorized staff at regular intervals
- Ensuring that authorized persons using the spindle, have carefully read and understood the operating manual
- Equipping staff with the appropriate protective equipment

## 02.5 Modifications and unauthorized changes

Modifications and unauthorized changes at the spindle by the operator are only permitted after consulting SPINOGY.

If unauthorized modifications are made, the issued CE declaration of conformity loses its validity and the operator legally becomes the machine manufacturer.

Opening and repairing the spindle may only be carried out by SPINOGY, only then proper functioning can be guaranteed.

## 02.6 Special hazard warnings

The following lists special hazards with the appropriate measures to prevent and avoid death and serious injury. These warnings must be read carefully and understood before commissioning. In addition, corresponding warnings must be attached by the operator to the machine into the spindle is installed.



### **WARNING: Flying parts**

Since the spindle operates at high speeds (up to 50.000 rpm and more), there is a risk of parts as chips and breaking tools hurling away. This can lead to serious injuries or even death.

- A suitable safety device that provides protection against flying parts has to be provided! It has to be provided with appropriate safety switches!
- Only use tools that comply with the standards!
- The direction of rotation of the tool must be observed.
- The tool must be firmly clamped!
- The entire clamping depth of the clamping systems must be used!
- Only operate tools within appropriate speed limits!
- Safety glasses must be worn!



### **WARNING: Rotating shaft**

There is a risk of serious hand injuries.

- Do not reach into the running machine!
- Turn off the spindle before cleaning or changing the tool!



### **DANGER: Electrical voltage**

There is a risk of electric shock, which can lead to serious injury or death.

- Before working on the spindle, switch it off and disconnect it from the electrical network!

# 03 Transport, packaging and storage

## 03.1 Transport

SPINOGY X30 must be transported in a stable packaging with sufficient padding. During the transport it must be taken care to avoid strong shocks or impacts as sensitive components such as the spindle bearings can be damaged, which has an influence on the service life, accuracy and function of the spindle.

Transport may only be carried out by qualified transport companies or qualified personnel.

The corresponding dimensions and weight specifications of the spindle can be found in the technical data in chapter 4.

## 03.2 Packaging

The packaging is intended to protect the spindle until assembly from transport damages and other external influences such as corrosion. The packaging should therefore only be removed shortly before assembly. In addition, the packaging should be kept, if possible, to protect the spindle in case of storage or to wrap it properly in case of return.

All packaging materials must be disposed at the appropriate collection points.

## 03.3 Storage

The following precautions must be arranged in case of storing the spindle:

- Liquid-cooled spindle: remove all coolant residues before storage
- Liquid-cooled spindle: the cooling channels must be emptied, and the coolant connections must be closed with the plugs supplied (or comparable plugs)
- The spindle must be stored vertically with the shaft and pointing downwards
- The spindle must be stored protected against dust, moisture and other environmental influences
- Mechanical vibrations of the spindle must be avoided
- The maximum storage time is two years
- The following conditions for storage must be observed:
  - o Temperature storage location: +10 bis 45 °C
  - o Relative humidity <40%
  - o Do not store outdoor



**NOTE: Grease distribution run**

To avoid considerable damage to the spindle bearings, a grease distribution run must be carried out after the spindle has been stored for a longer period (see chapter 6 commissioning).

# 04 Technical description

## 04.1 Configuration possibilities and technical data

SPINOGY X30 is available in twelve basic versions (Manual, semi-automatic and automatic tool change), additionally further configurations (Options) are possible.

The operating manual includes the description of all spindle types and options.

### Basic version (Manual tool change)

ITEM NO.:	XP131	XP130
Cooling method	Liquid cooling	Air cooling
Tool interface	ER25	
Clamping range [mm]	1 to 17	
Power [kW]	4,0 (S1)   4,5 (S6)	
Voltage [V]	400	
Current [A]	7,5 (S1)   8,4 (S6)	
Number of poles	2-pole	
Rotational speed [rpm]	25.000	
Bearings	Steel bearings	
Temperature sensor	PTC-130°C (coil-end)	
Motor plug	9-pole straight	9-pole angled
Coolant connection	2 x 8 mm straight	-
Fan	-	24 V fan
Protection class	IP54	IP20 (without filter)
Weight [kg]	9,5	9,4

### Basic version (Semi-automatic tool change)

ITEM NO.:	XP129	XP128
Cooling method	Liquid cooling	Air cooling
Tool interface	QTC-HSK-C32	
Power [kW]	4,0 (S1)   4,5 (S6)	
Voltage [V]	400	
Current [A]	7,5 (S1)   8,4 (S6)	
Number of poles	2-pole	
Rotational speed [rpm]	25.000	
Bearings	Steel bearings	
Temperature sensor	PTC-130°C (coil-end)	
Motor plug	9-pole straight	9-pole angled
Coolant connection	2 x 8 mm straight	-
Fan	-	24 V fan
Protection class	IP54	IP20 (without filter)
Weight [kg]	9,8	9,8

### Basic version (Automatic tool change)

ITEM NO.:	XP093	XP100	XP094	XP101
Cooling method	Liquid cooling		Air cooling	
Tool interface	SK30	HSK-E40	SK30	HSK-E40
Power [kW]	4,0 (S1)   4,5 (S6)			
Voltage[V]	400			
Current [A]	7,5 (S1)   8,4 (S6)			
Number of poles	2-pole			
Rotational speed [rpm]	25.000			
Bearings	Steel bearings			
Temperature sensor	PTC-130°C (coil-end)			
Rotational speed sensor	Inductive			
Clamping position sensor	2 x Inductive (clamped with tool/without tool)			
Piston position sensor	Inductive			
Motor plug	9-pole straight		9-Pol angled	
Sensor plug	17-pole straight		17-Pol angled	
Cooling connection	2 x 8 mm straight		-	
Pneumatic connection	3 x 6 mm straight (RP, PPR, TP*)		3 x 6mm angled (RP, PPR, TP*)	
Fan	-		24 V fan	
Protection class	IP54		IP20 (without filter)	
Weight [kg]	12,7	12,7	12,7	12,7

\*RP: Release pressure, PPR: pneumatic piston return, TP: taper blow

### Option motor

OPTION NO.:	POWER [KW]	VOLTAGE [V]	NUMBER OF POLES [-]	TYPE OF SPINDLE
CG106	3,0	400	2	For all types of X30
CG107	3,0	400	4	
CG108	4,0	400	2	Basic configuration all X30
CG109	4,0	400	4	For all types of X30
CG110	5,0	400	2	
CG111	5,0	400	4	

OPTION NO.:	DESCRIPTION	TYPE OF SPINDLE
CG121	Stator potting	Included in option CG110 & CG111

#### Option rotational speed

OPTION NO.:	ROTATIONAL SPEED [RPM]	TYPE OF SPINDLE
CG112	20.000	For all types of X30
CG113	25.000	Basic configuration all X30
CG114	30.000	For all types of X30
CG115	35.000	For all types of X30 (Hybrid bearings front included)

#### Option spindle bearings

OPTION NO.:	BEARING TYPE	TYPE OF SPINDLE
CG117	Steel bearings front 6008	Basic configuration all X30
CG118	Hybrid bearings front 6008	For all types of X30
CG119	Steel bearings back 6005	Basic configuration all X30
CG120	Hybrid bearings back 6005	For all types of X30

#### Option temperature sensor

OPTION NO.:	TEMPERATURE SENSOR	TYPE OF SPINDLE
CG014	Measurement bearings front (PT100)	For all types of X30
CG015	Monitoring bearing front (PTC-70°C)	
CG016	Monitoring bearing back (PT100)	
CG017	Monitoring bearing back (PTC-70°C)	
CG018	Measurement coil end (PT100)	
CG019	Monitoring coil end (PTC-130°C)	Basic configuration
CG033	Without temperature sensor	For all types of X30



### Option rotational speed sensor

OPTION NO.:	ROTATIONAL SPEED SENSOR	TYPE OF SPINDLE
CG020	Encoder analog (rotational speed)	For all types of X30
CG021	Encoder analog (rotational speed, direction of rotation)	
CG022	Encoder analog (rotational speed, direction of rotation,	
CG136	Encoder digital (rotational speed)	
CG137	Encoder digital (rotational speed, direction of rotation)	
CG138	Encoder digital (rotational speed, direction of rotation,	
CG049	Inductive (rotational speed)	Basic configuration at XP093, XP094, XP100, XP101
CG104	Inductive speed control	For all types of X30
CG036	Without rotational speed sensor	Basic configuration at XP128, XP129, XP130, XP131

### Option clamping position sensor (at XP093, XP04, XP100, XP101)

OPTION NO.:	CLAMPING POSITION SENSOR	TYPE OF SPINDLE
CG034	Inductive (clamped with / without tool)	Basic configuration at XP093, XP094, XP100, XP101
CG037	Without clamping position sensor	Choose at XP093, XP094, XP100, XP101

### Option piston position sensor (at XP093, XP04, XP100, XP101)

OPTION NO.:	PISTON POSITION SENSOR	TYPE OF SPINDLE
CG035	Inductive	Basic configuration at XP093, XP094, XP100, XP101

### Option plug

OPTION NO.:	PLUG	TYPE OF SPINDLE
CG023	Motor 9-pole straight	Basic configuration at XP093/XP100/XP129/XP131
CG024	Motor 9-pole angled	Basic configuration at XP094/XP101/XP128/XP130
CG025	Sensor 17-pole straight	Basic configuration at XP093/XP100, at XP129/XP131 necessary from the second sensor on
CG026	Sensor 17-pole angled	Basic configuration at XP094/XP101, at XP128/XP130 necessary from the second sensor on

### Option coolant connection

OPTION NO.:	MEDIA CONNECTION	TYPE OF SPINDLE
CG027	Cooling connection straight (coolant)	Basic configuration at XP093/XP100/XP129/XP131
CG028	Cooling connection angled (coolant)	Choose at XP093/XP100/XP129/XP130
CG051	Pneumatic connection straight	Basic configuration at XP093/XP100, choose at XP094/XP101
CG052	Pneumatic connection angled	Basic configuration at XP094/XP101, choose at XP093/XP100

#### Option clamping nut

OPTION NO.:	DESCRIPTION	TYPE OF SPINDLE
CG041	Mini clamping nut ER25	Basic configuration at XP130/XP131
CG050	Without clamping nut ER25	Choose at XP130/XP131

#### Option warranty

OPTION NO.:	DESCRIPTION	TYPE OF SPINDLE
CG047	3 years warranty	Basic configuration
CG048	Extended warranty to 5 years	For all types of X30

#### Option cooling method and protective class

OPTION NO.:	DESCRIPTION	TYPE OF SPINDLE
CG123	Option cooling – with filter (IP50)	Choose at XP094/XP101/XP128/XP130
CG125	Option protective class – Upgrade IP65	Choose at XP093/XP100/XP129/XP131

#### Option personalize

OPTION NO.:	DESCRIPTION	TYPE OF SPINDLE
CG098	Logo lasered	For all types of X30
CG140	Branding X30	For all types of X30

## 04.2 Dimensions

ER25 liquid cooled (Item no.: XP131)



**ER25 air cooled (Item no.: XP130)**



**QTC-HSK-C32 liquid cooled (Item no.: XP129)**



**QTC-HSK-C32 air cooled (Item no.: XP128)**

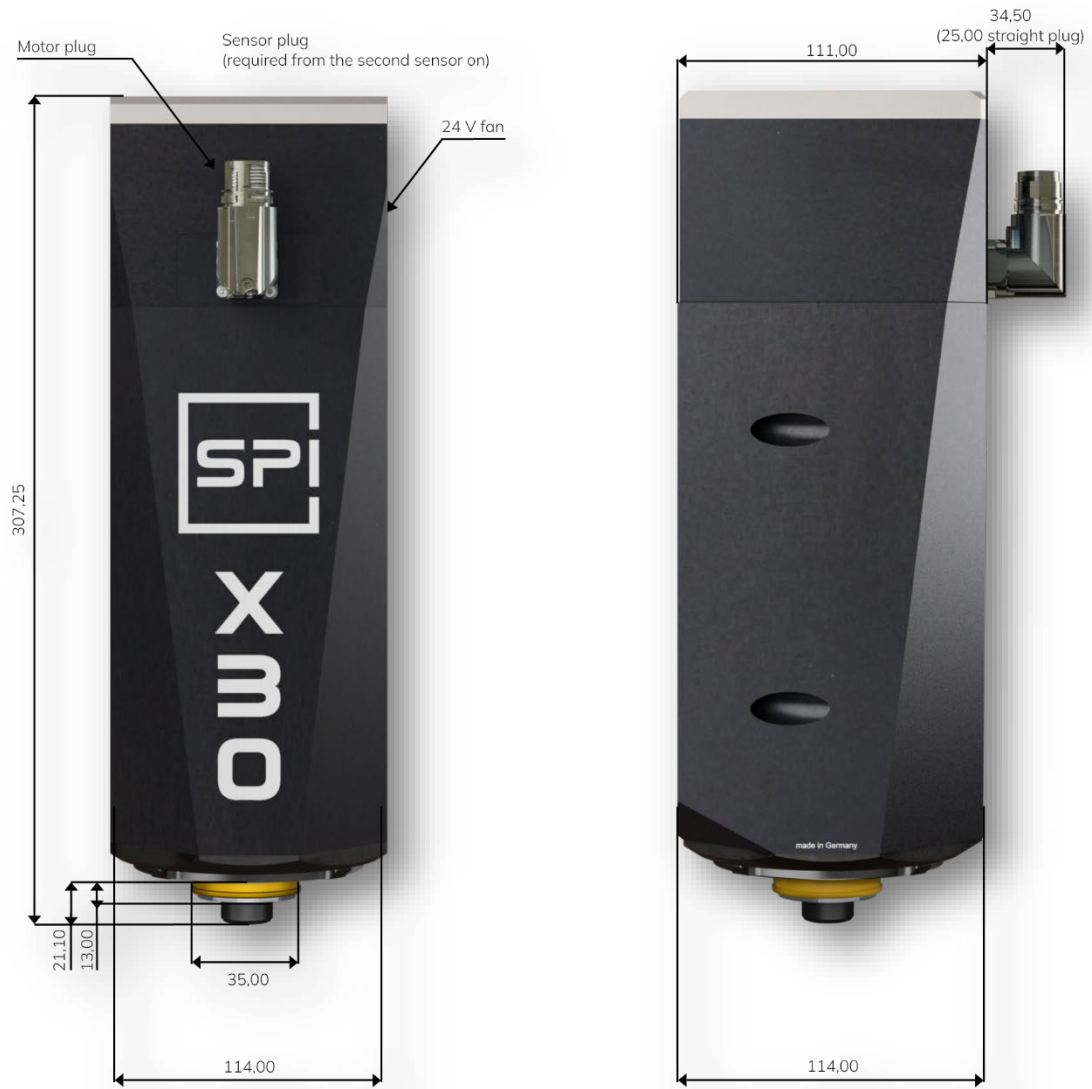

**SK30 liquid cooled (Item no.: XP093)**

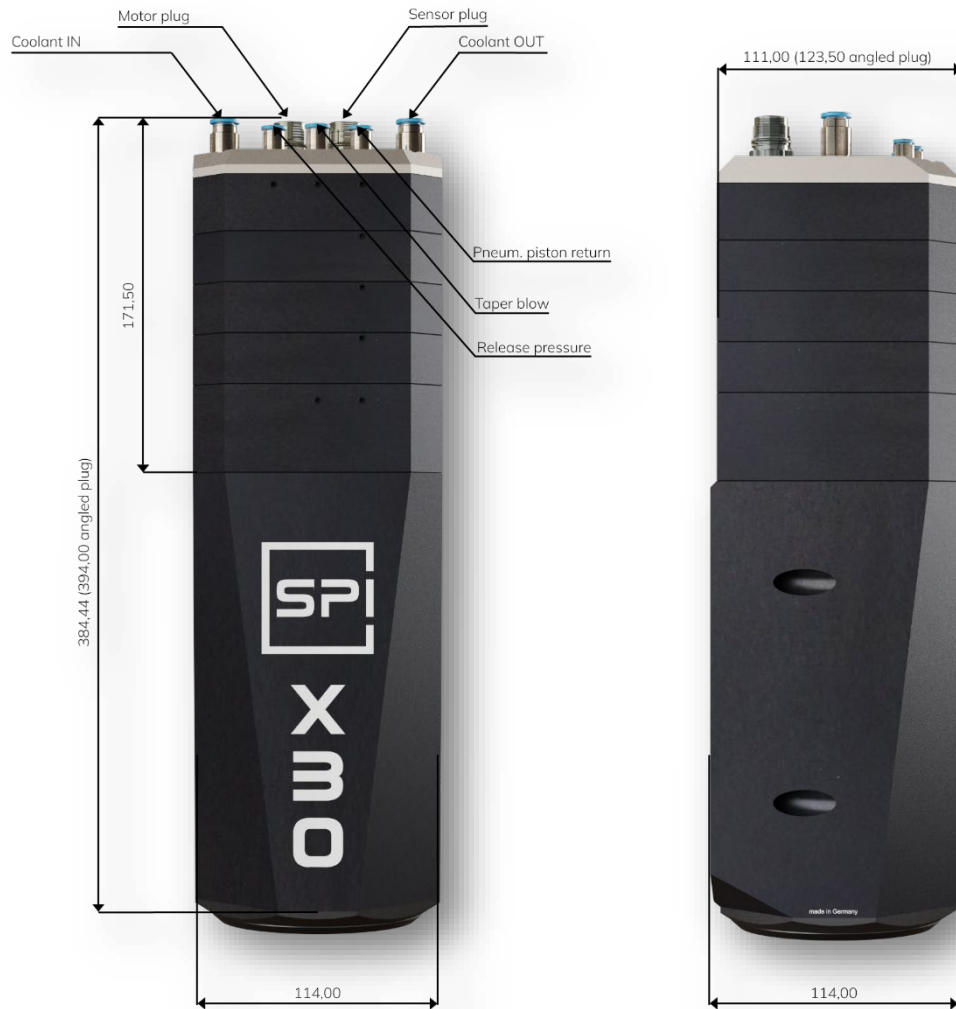

**HSK-E40 liquid cooled (Item no.: XP100)**

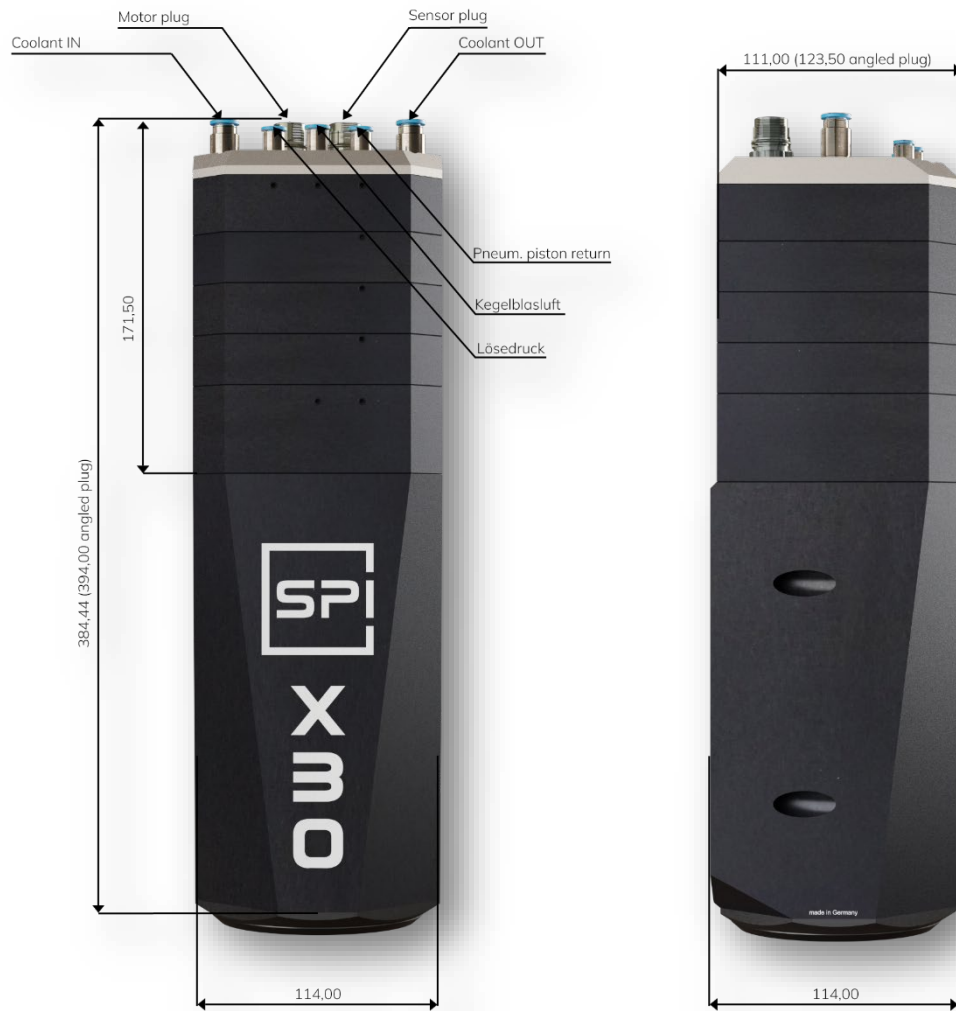



**SK30 air cooled (Item no.: XP094)**



**HSK-E40 air cooled (Item no.: XP101)**



### Dimension of z-axis attachment

The bore pattern of all X30 spindles is identical. The spindle can be screwed either from the front or from the rear. The attachment to the z-axis is described in chapter 05, installation.

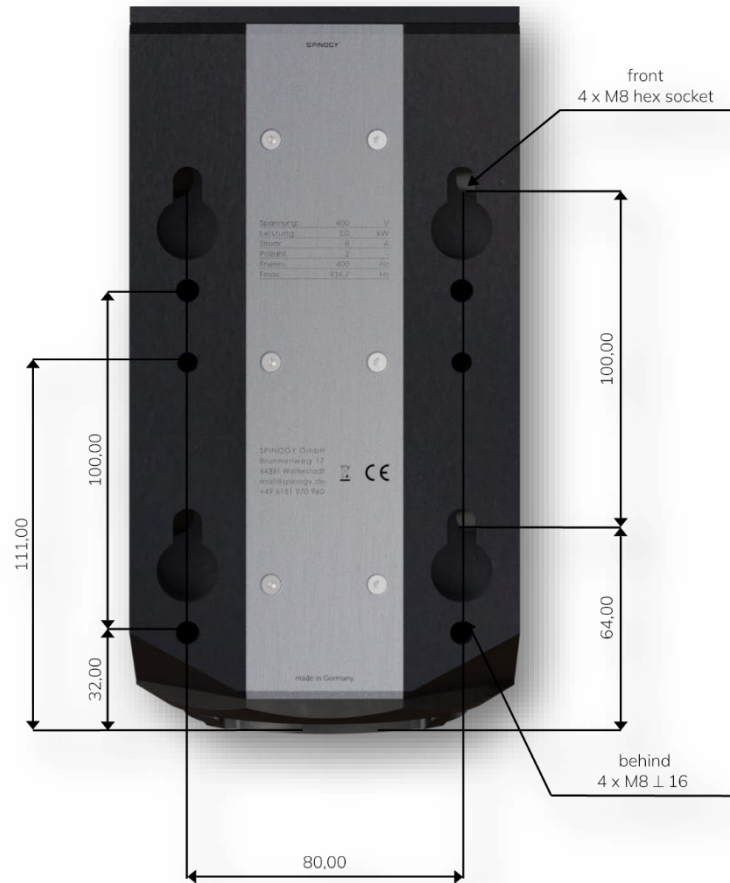

The following tolerances must be observed for the holes on the z-axis or on an adapter plate.

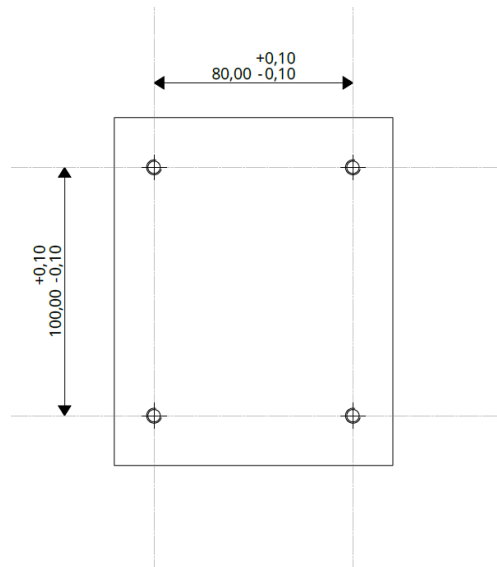

## 04.3 Cooling

SPINOGY X30 is available with two different cooling variants. A distinction can be made between liquid cooling and air cooling (forced air ventilation). The cooling ensures a constant temperature while operating the spindle and ensures that the service life of the bearings and motor coil is increased.



**NOTE: Housing temperature max. 45°C**

The housing temperature must not exceed 45°C, otherwise the service life of the bearings and the motor coil will be shortened. Always ensure sufficient cooling and check the housing temperature if no temperature monitoring is installed.



**WARNING: Hot shell finish**

If the housing temperature at the spindle exceeds 45°C, severe burns may occur according to the specifications in DIN EN ISO 13732-1. Skin contact must be avoided.

### Technical data: Liquid cooling

Coolant	1/3 Glycosol-2/3 water mix (e.g. SPINOGY coolant or concentrate)
Pre-temperature [°C]	minimum 20
Volume flow [l/min]	minimum 1,5
Return temperature [°C]	maximum 40
Noise pressure level [dB(A)]	52 (at standstill in combination with Xcool)
	64 (at 30.000 rpm)



**NOTE: Do not use pure or distilled water.**

Do not use pure or distilled water. The use of pure or distilled water can lead to considerable corrosion damage. Always add a certain amount of corrosion protection.

### Technical data Air cooling:

Voltage type	DC
Nominal voltage [V]	24
Voltage range [V]	12 .. 27,6 (for motor cables > 15 m increase voltage by 1 to 2%.)
Rotational speed [rpm]	13.000
Nominal current [A]	1,58
Power consumption [W]	50
Noise power level [B]	8,2
Noise pressure level [dB(A)]	73



**NOTE: Keep the intake area of the fan free**

The intake area of the fan must always be kept free so that sufficient air can be drawn in, and the corresponding cooling capacity can be ensured. The protective grille of the fan must be kept free of dirt, and the fan inlet must be kept free of attachment parts.

## 04.4 Tool interfaces

X30 is available in the version with manual (ER25), semi-automatic (HSK-C32) and with automatic tool change (SK30 and HSK-E40).

### ER25 (Item no.: XP130, XP131)

The spindles with manual tool change have the following clamping ranges:

TOOL INTERFACE	CLAMPING RANGE [mm]
ER25	1 to 17

The tightening torques for the respective clamping ranges can be found in chapter 06.3.

### HSK-C32 (Item no.: XP128, XP129)

The spindles with semi-automatic tool change are also called QTC (Quick Tool Change). With the QTC it is not the tool that is changed by hand, but the tool holder. This requires a special torque wrench with a preset tightening torque of 3 Nm (available from SPINOGY).

### SK30 und HSK-E40 (Item no.: XP093, XP094, XP100, XP101)

The spindles with automatic tool change are designed for tool holders with planar support. This ensures optimum centering and fixed axial positioning of the holders. The tool holders with planar support, which provide the matching counterpart to the spindle shafts of the X30, are available from SPINOGY. Tool holders without planar support are readily compatible with the spindles.

The HSK interface is designed according to DIN 69863 (HSK-E40), the SK30 interface according to DIN 69871 with tightening bolts for tool holders in accordance with DIN 69872.

## 04.5 Motor characteristics

### 3,0 kW 400 V 2-pole asynchronous motor (Option no.: CG106)

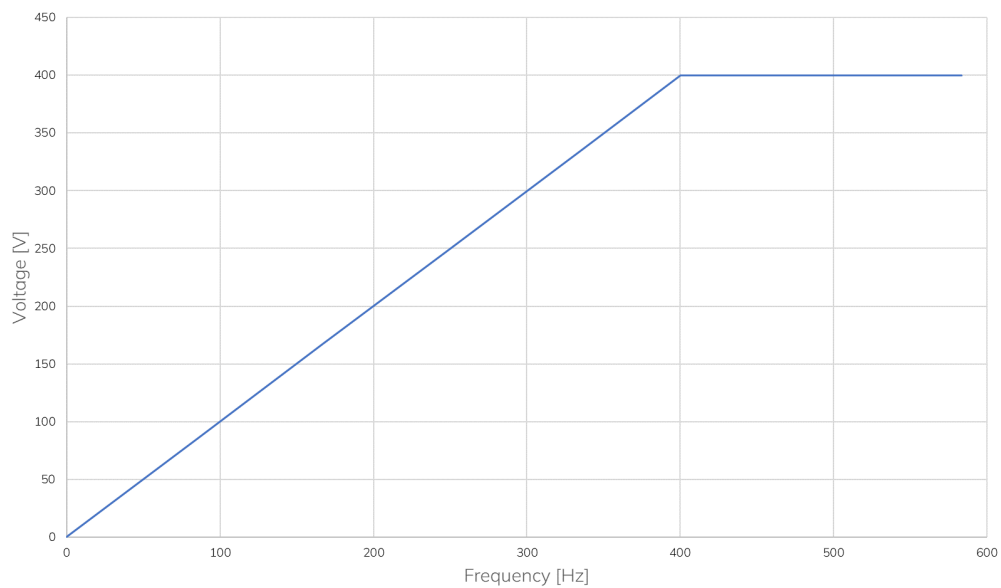
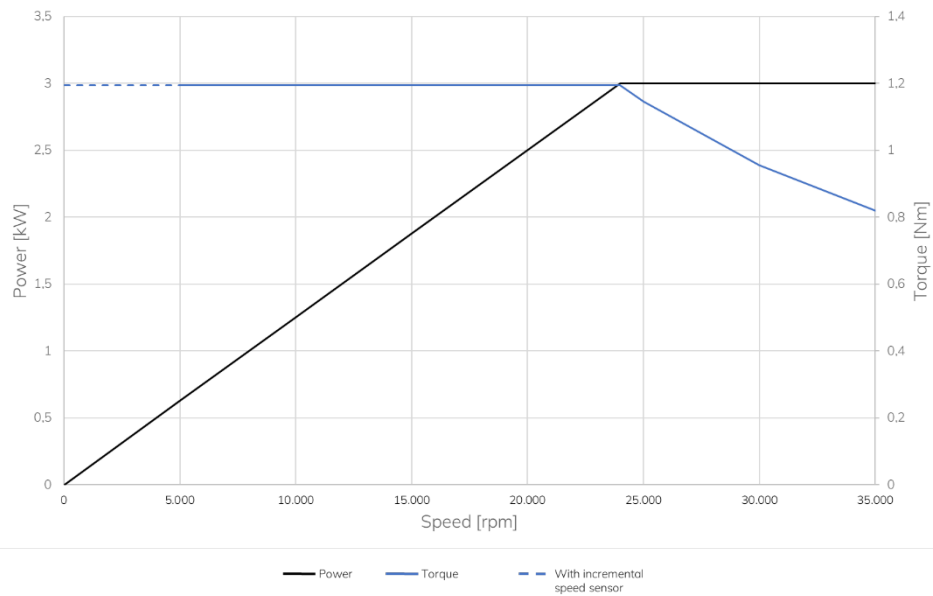

DESCRIPTION	VOLTAGE [V]	FREQUENCY [Hz]
Base frequency	400	400
Option rotational speed 20.000 rpm	333	333,3
Option rotational speed 25.000 rpm	400	416,7
Option rotational speed 30.000 rpm	400	500
Option rotational speed 35.000 rpm	230	583,3

Power | Current (S1): 3,0 kW | 6,3 A  
 Power | Current (S6): 3,3 kW | 6,9 A

### 3,0 kW 400 V 4-pole asynchronous motor (Option no.: CG107)

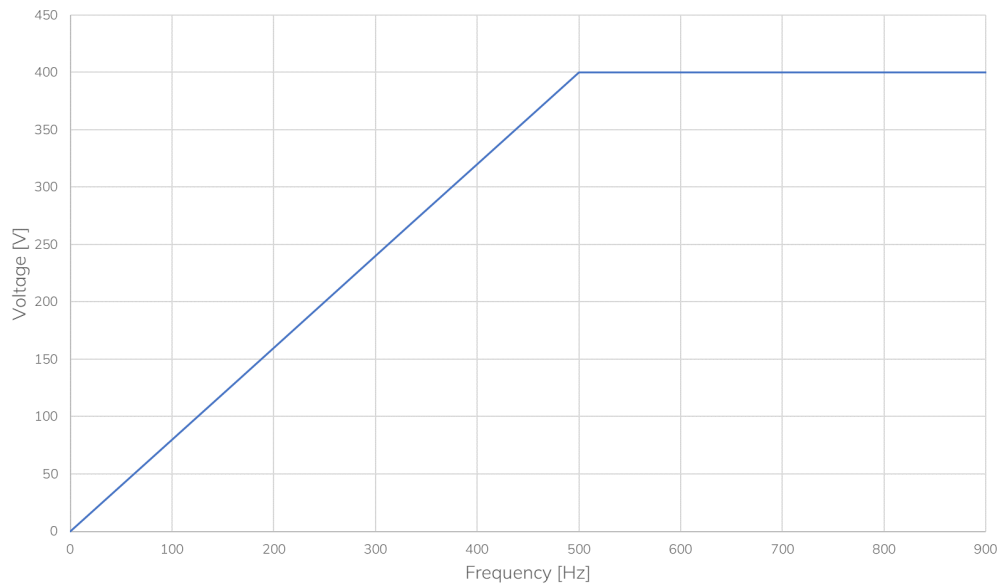
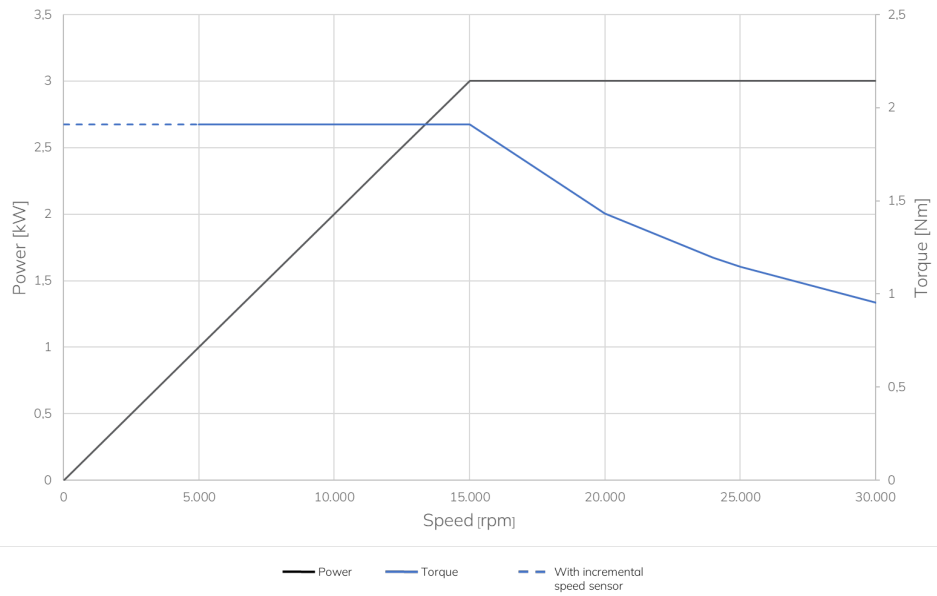

DESCRIPTION	VOLTAGE [V]	FREQUENCY [Hz]
Base frequency	400	500
Option rotational speed 20.000 rpm	400	666,7
Option rotational speed 25.000 rpm	400	833,3
Option rotational speed 30.000 rpm	400	1000

Power | Current (S1): 3,0 kW | 6,3 A  
 Power | Current (S6): 3,3 kW | 6,9 A

**4,0 kW 400 V 2-pole asynchronous motor (Option no.: CG108)**

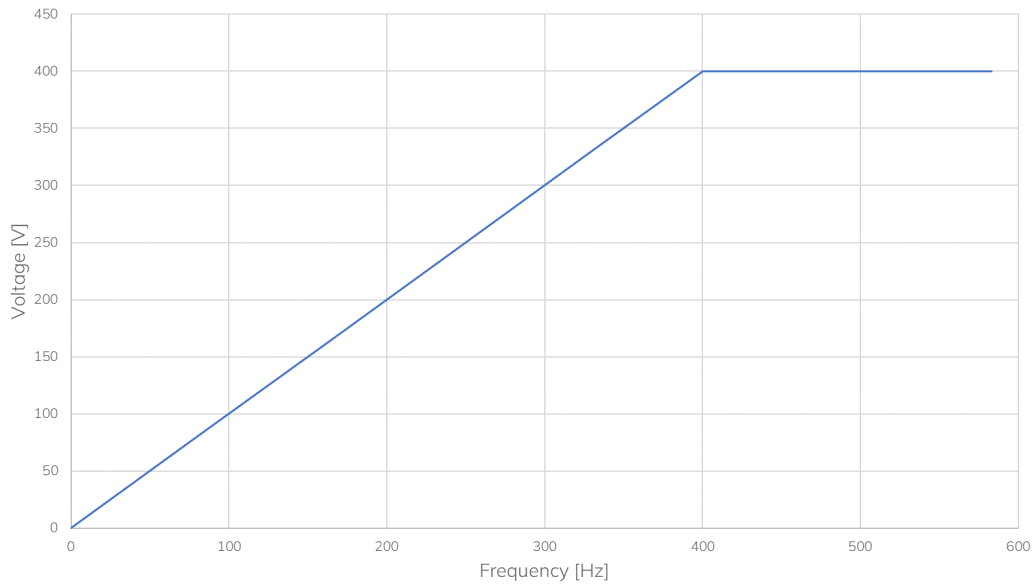
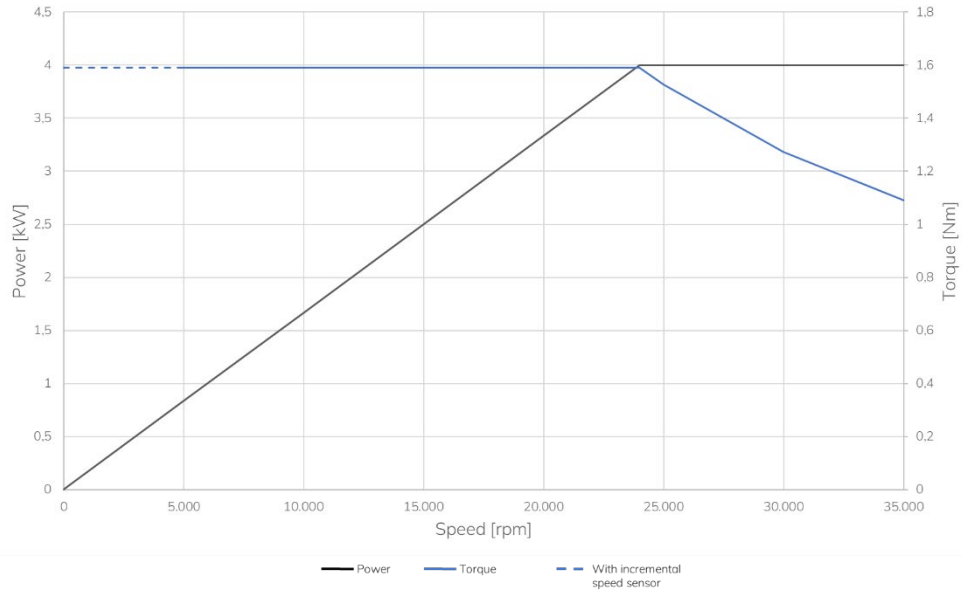

DESCRIPTION	VOLTAGE [V]	FREQUENCY [Hz]
Base frequency	400	400
Option rotational speed 20.000 rpm	333	333,3
Option rotational speed 25.000 rpm	400	416,7
Option rotational speed 30.000 rpm	400	500
Option rotational speed 35.000 rpm	400	583,3

Power | Current (S1): 4,0 kW | 8,4 A  
 Power | Current (S6): 4,5 kW | 9,5 A



**4,0 kW 400 V 4-pole asynchronous motor (Option no.: CG109)**

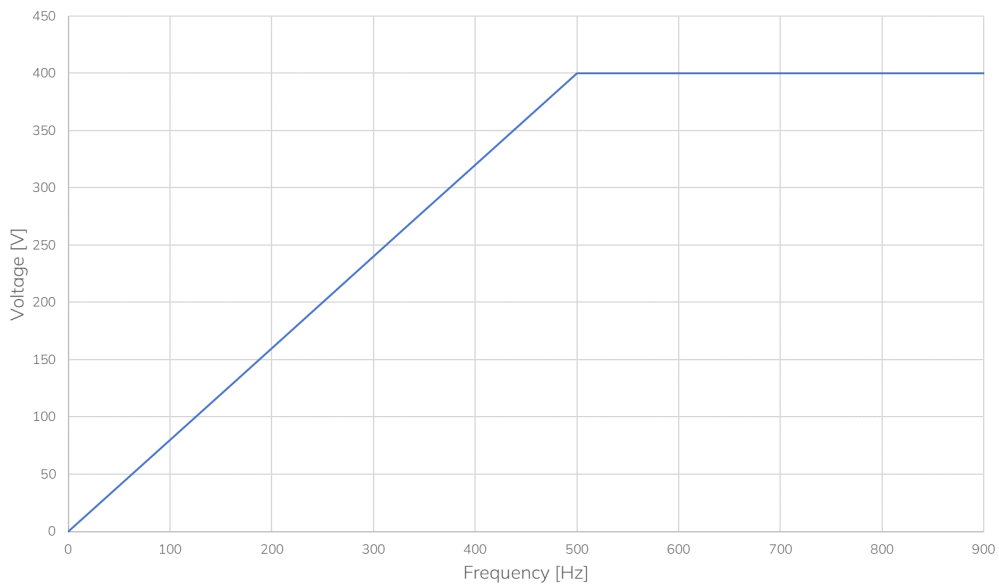
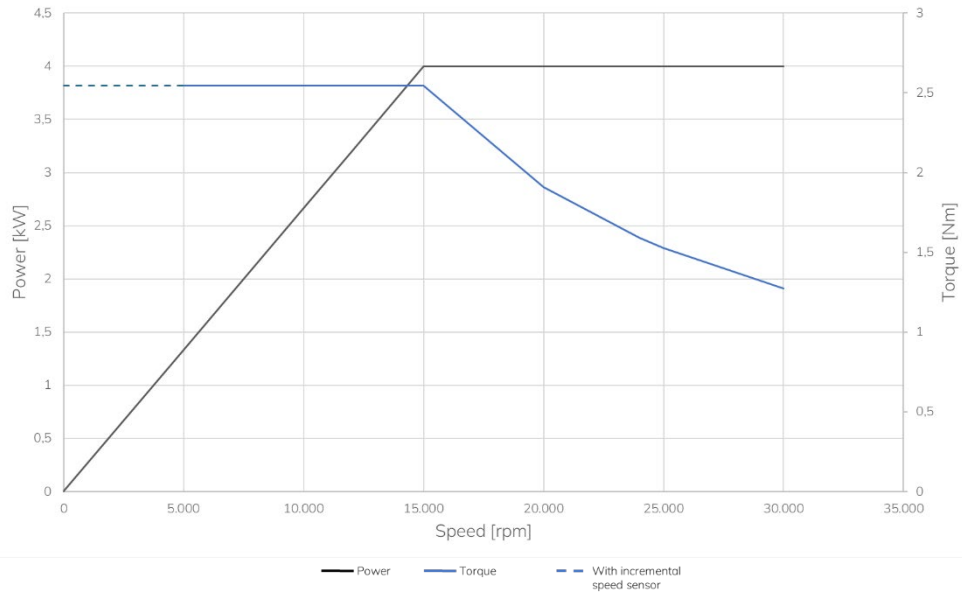

DESCRIPTION	VOLTAGE [V]	FREQUENCY [Hz]
Base frequency	400	500
Option rotational speed 20.000 rpm	400	666,7
Option rotational speed 25.000 rpm	400	833,3
Option rotational speed 30.000 rpm	400	1000

Power | Current (S1): 4,0 kW | 8,4 A  
 Power | Current (S6): 4,5 kW | 9,5 A

### 5,0 kW 400 V 2-pole asynchronous motor (Option no.: CG110)

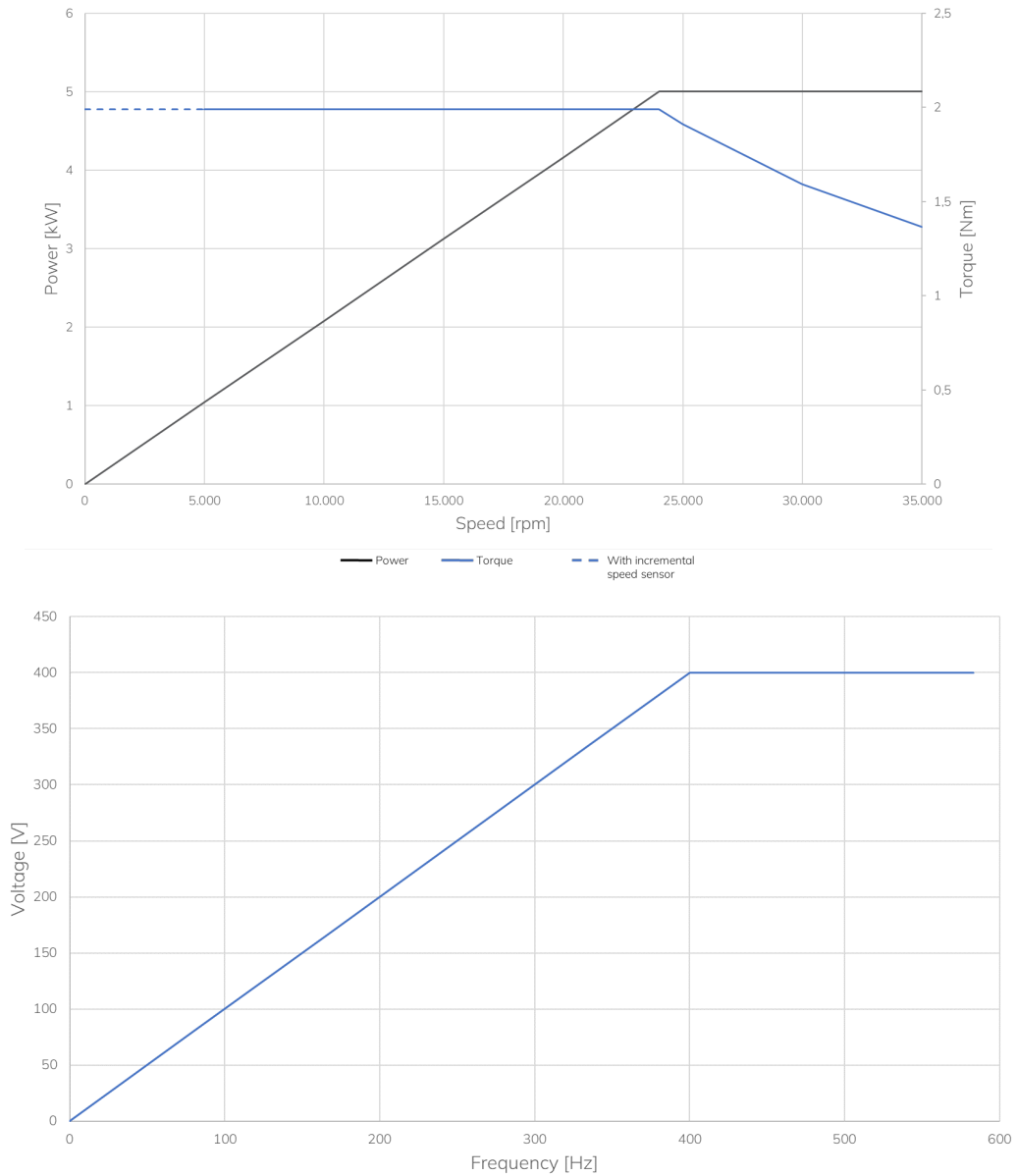

DESCRIPTION	VOLTAGE [V]	FREQUENCY [Hz]
Base frequency	400	400
Option rotational speed 20.000 rpm	333	333,3
Option rotational speed 25.000 rpm	400	416,7
Option rotational speed 30.000 rpm	400	500
Option rotational speed 35.000 rpm	400	583,3

Power | Current (S1): 5,0 kW | 10,5 A  
 Power | Current (S6): 5,5 kW | 11,6 A

**5,0 kW 400 V 4-pole asynchronous motor (Option no.: CG111)**

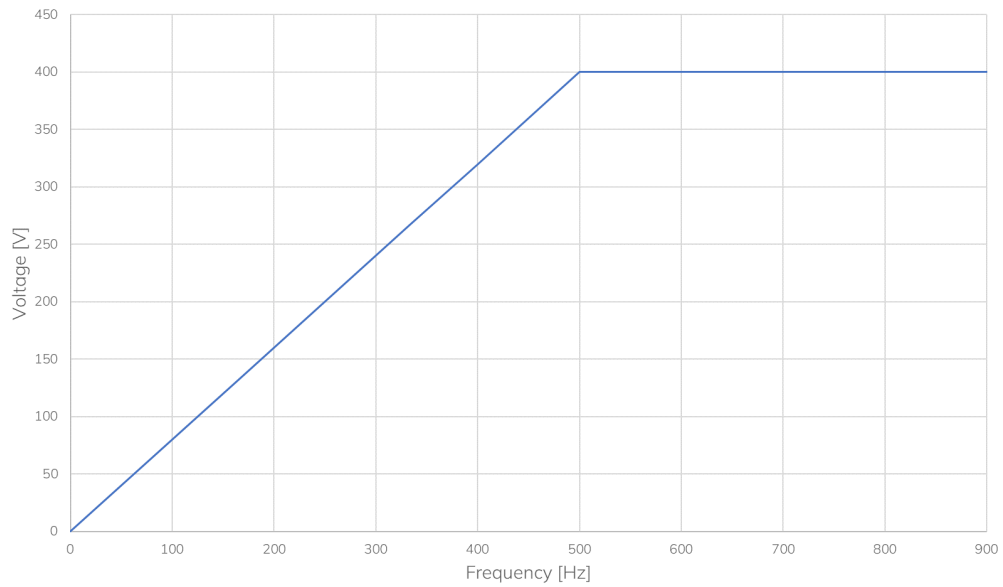
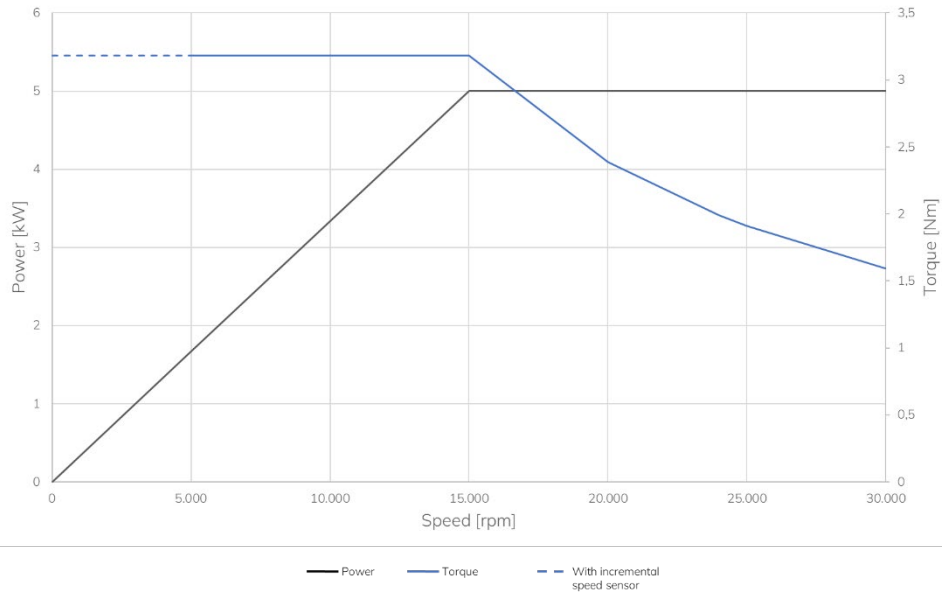

DESCRIPTION	VOLTAGE [V]	FREQUENCY [Hz]
Base frequency	400	500
Option rotational speed 20.000 rpm	400	666,7
Option rotational speed 25.000 rpm	400	833,3
Option rotational speed 30.000 rpm	400	1000

Power | Current (S1): 5,0 kW | 10,5 A  
 Power | Current (S6): 5,5 kW | 11,6 A

### 3,0 kW 230 V 2-pole asynchronous motor (Option no.: CG141)

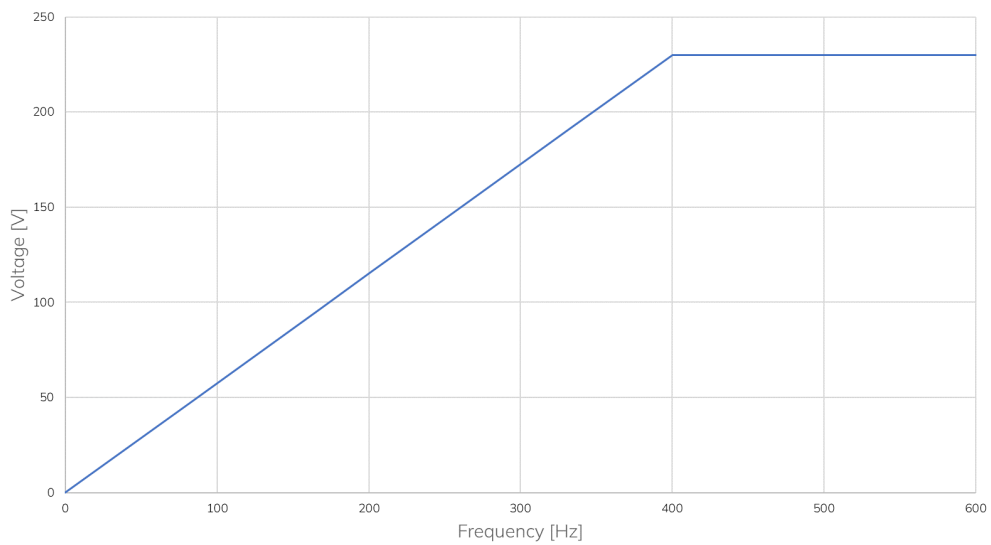
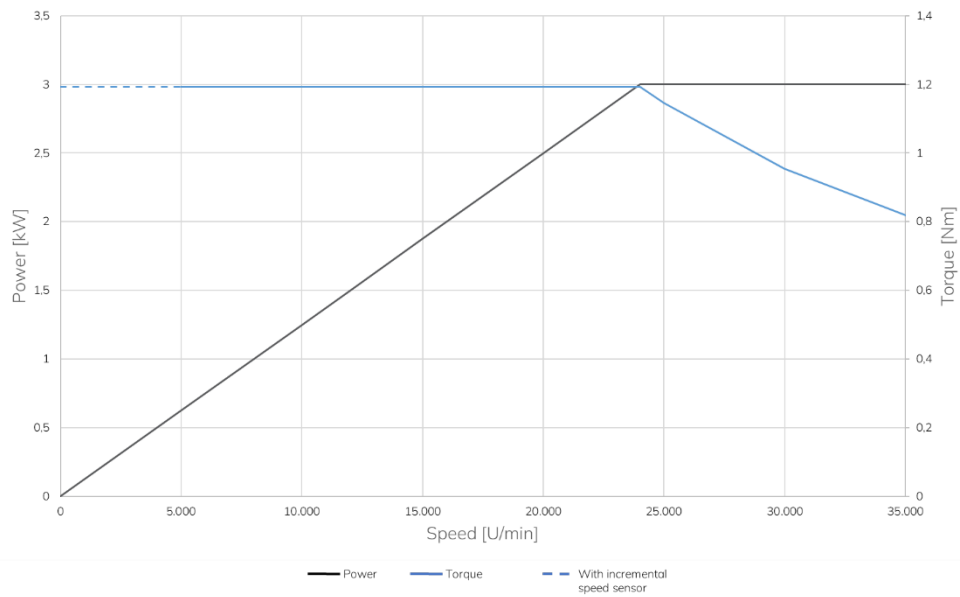

DESCRIPTION	VOLTAGE [V]	FREQUENCY [Hz]
Base frequency	230	400
Option rotational speed 20.000 rpm	191,5	333,3
Option rotational speed 25.000 rpm	230	416,7
Option rotational speed 30.000 rpm	230	500
Option rotational speed 35.000 rpm	230	583,3

Power | Current (S1): 3,0 kW | 10,8 A  
 Power | Current (S6): 3,3 kW | 12,0 A

### 3,0 kW 230 V 4-pole asynchronous motor (Options-Nr.: CG142)

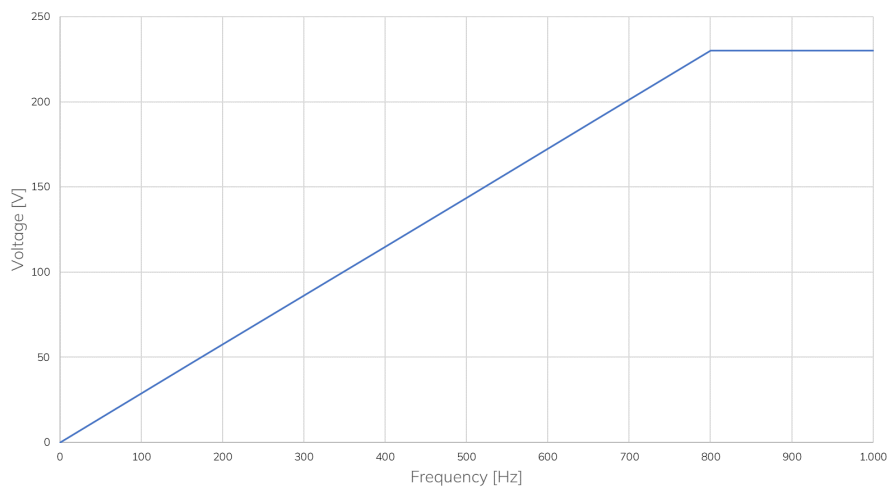
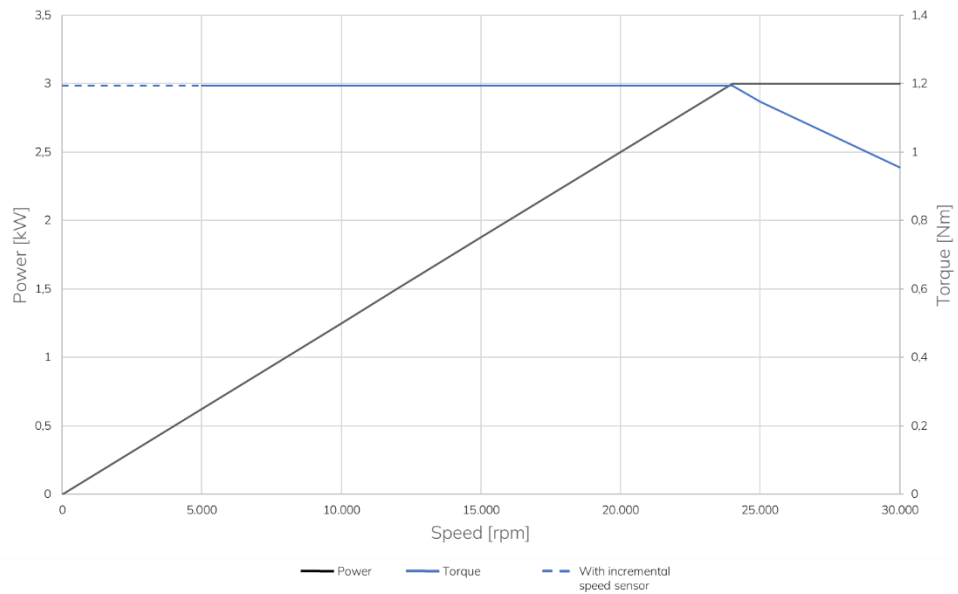

DESCRIPTION	VOLTAGE [V]	FREQUENCY [Hz]
Base frequency	230	800
Option rotational speed 20.000 rpm	230	666,7
Option rotational speed 25.000 rpm	230	833,3
Option rotational speed 30.000 rpm	230	1000

Power | Current (S1): 3,0 kW | 10,8 A  
 Power | Current (S6): 3,3 kW | 12,0 A



**NOTE: The specified V/F characteristics must be observed**

The frequency converter must be programmed according to the respective speed option (programmed frequency converters are available from SPINOGY), otherwise considerable damage to the motor may occur. Corresponding parameter lists are enclosed.



**NOTE: The maximum specified speed must be observed**

The maximum specified speed (see speed option) of the spindle must not be exceeded, as this can lead to considerable damage to the spindle bearing and other rotating components. The spindle is prepared for the respective selected speed option (spindle bearing, balancing quality).

## 04.6 Heat detector

Depending on the option, the temperature can either be monitored or measured directly (additional display or integration into control system required). It is possible to use temperature monitoring or measurement at three points.

### Temperature monitoring PTC (Option no.: CG015, CG017, CG019)

Operating location		Coil end	Bearing
Type of sensor		PTC	front / back
Measuring temperature	$T_{\text{sense}} [^{\circ}\text{C}]$	130	70
Max. Operating voltage (TA = 0 ... 40 °C)	$V_{\text{max}} [\text{V DC}]$	30	30
Measuring voltage (TA = -40 °C ... Tsense + 5 K)	$V_{\text{meas}} [\text{V DC}]$	≤ 2,5	≤ 2,5
Max. measuring voltage	$V_{\text{meas,max}} [\text{V DC}]$	7,5	7,5
Nominal resistance (VPTC ≤ 2,5 V)	$R_R [\Omega]$	≤ 250	≤ 250
Response time	$t_a [\text{s}]$	< 3	< 3
Operating temperature range (V ≤ Vmeas,max)	$T_{\text{op}} [^{\circ}\text{C}]$	-40/ $T_{\text{sense}} + 23$	-40/ $T_{\text{sense}} + 23$
Operating temperature range (V = Vmax)	$T_{\text{op}} [^{\circ}\text{C}]$	0/+40	0/+40

$T_{\text{sense}} \pm \Delta T$	$R(T_{\text{sense}} - \Delta T)$ ( $V_{\text{PTC}} \leq 2,5 \text{ V}$ )	$R(T_{\text{sense}} + \Delta T)$ ( $V_{\text{PTC}} \leq 2,5 \text{ V}$ )	$R(T_{\text{sense}} + 15 \text{ K})$ ( $V_{\text{PTC}} \leq 7,5 \text{ V}$ )	$R(T_{\text{sense}} + 23 \text{ K})$ ( $V_{\text{PTC}} \leq 7,5 \text{ V}$ )
$70 \pm 5 \text{ }^{\circ}\text{C}$	≤ 570 Ω	≥ 570 Ω	-	≥ 4 kΩ
$130 \pm 5 \text{ }^{\circ}\text{C}$	≤ 550 Ω	≥ 1330 Ω	≥ 4 kΩ	-

### Temperature measurement PT100 (Option no.: CG014, CG016, CG018)

<b>Operating location</b>		Coil end & bearing front / bearing back
<b>Type of sensor</b>		PT100
<b>Nominal resistance</b>	R [ $\Omega$ ]	100 at 0 °C
<b>Temperature range</b>	T [°C]	-70 ... +500
<b>Tolerance class</b>		Class B (F 0,3)
<b>Measurement circuit</b>	I [mA]	0,3 ... 1,0

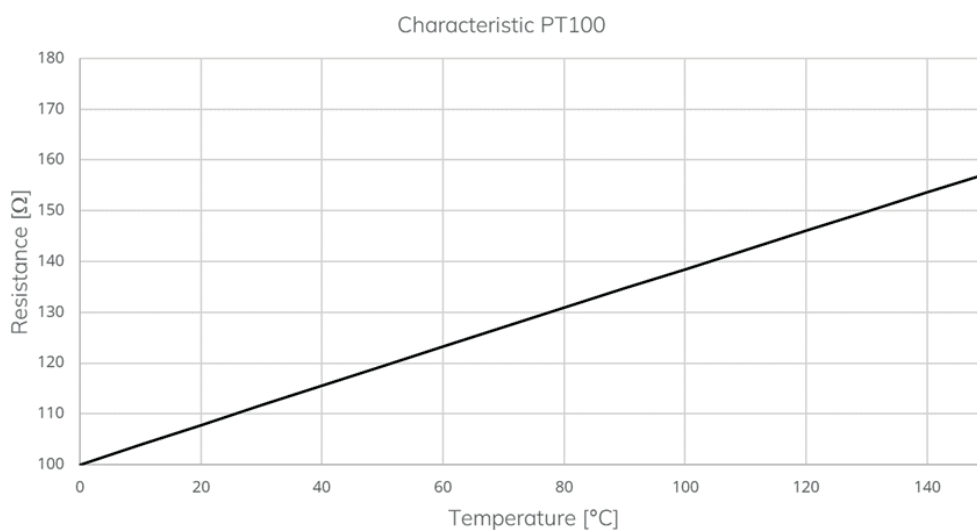

## 04.7 Rotation sensor

Speed monitoring or speed control can be done in different ways depending on the option. Either an inductive speed sensor or a magneto-resistive speed sensor is used.

### Inductive speed sensor (option-no.: CG049, CG104)

There are two options for using the inductive speed sensor. Option CG049 is only for monitoring the speed and the sensor scans a pole ring with two circumferential grooves (two pulses per rotation). Option CG104 is for a simplified speed control. In this case the sensor scans a pole ring with 32 circumferential grooves (32 pulses per revolution).

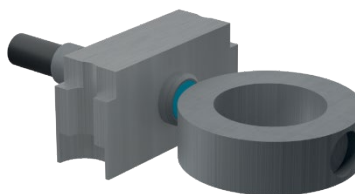

<b>Type of sensor</b>	Inductive proximity sensor
<b>Power supply voltage [V DC]</b>	10 ... 30
<b>Current consumption [mA]</b>	≤ 100
<b>Switching output</b>	PNP
<b>Switch logic</b>	Normally open
<b>Operating frequency [Hz]</b>	4.200

**Encoder analog or digital (option-no.: CG020, CG021, CG022, CG136, CG137, CG138)**

A pole ring with 60 teeth is tapped with the magnetoresistive speed sensor. Depending on the selected option, either speed (CG020, CG136), speed and direction of rotation (CG021, CG137) or speed, direction of rotation and absolute position (CG022, CG138) can be tapped. For option CG022 and CG138 the sensor additionally acquires a reference signal.

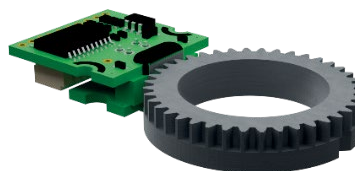

<b>Type of sensor</b>	Analog (CG020, CG021, CG022)
<b>Power supply voltage <math>V_{cc}</math> [V]</b>	4,5 ... 5,5
<b>Current consumption [mA]</b>	26
<b>Input frequency [kHz]</b>	10 ... 500
<b>Output voltage [V]</b>	0,8 ... 1,2

<b>Type of sensor</b>	Digital (CG136, CG137, CG138)
<b>Power supply voltage <math>V_{cc}</math> [V]</b>	4,5 ... 5,5
<b>Flanks per pitch</b>	32
<b>Current consumption [mA]</b>	26 ... 400
<b>Input frequency [kHz]</b>	10 ... 500
<b>Output voltage High [V]</b>	4,6 ... 5,0
<b>Output voltage Low [V]</b>	0,0 ... 0,4



## 04.8 Clamping position and piston position sensor

All spindles of X30 with automatic tool change have two sensors for clamping position monitoring and one sensor for piston position in the basic version.

<b>Type of sensor</b>	Inductive proximity sensor
<b>Power supply voltage [V DC]</b>	10 ... 30
<b>Current consumption [mA]</b>	≤ 100
<b>Switching output</b>	PNP
<b>Switch logic</b>	Normally open
<b>Operating frequency [Hz]</b>	600

## 04.9 Labyrinth seal

Every SPINOGY X30 has a 5-stage labyrinth seal around the front bearing point, which ensures a high sealing effect against strong splash impact not only when the shaft is also rotating when it is stationary. This eliminates the need for a sealing air and increases maintenance intervals, resulting in a more sustainable and economical solution.



**NOTE: Provide additional suction when installing overhead**

When installing the spindle overhead and using cool lubricant, there is a flooding situation, which is why suction must be provided in addition to the labyrinth seal, as otherwise contamination and thus damage to the spindle bearings may occur.

# 05 Installation

## 05.1 Transport damages check

The entire delivery must be checked for transport damage after acceptance. In case of external damage to the packaging, this must be documented. After unpacking the SPINOGY X30 and the additional scope of delivery, the products must be checked directly for transport damage. In case of damage to the products, this must be documented. Despite the greatest care in packaging and shipping our products, transport damage may occur as a result of improper handling or force majeure in transit. Defective or damaged products must not be put into operation. The products must always be used in perfect condition.

If transport damage is detected or if there are any questions, SPINOGY must be contacted immediately.

## 05.2 Completeness check

The content of the consignment must be checked for completeness. If any parts are missing, contact SPINOGY and do not put the spindle into operation for the moment.

### Scope of delivery:

XP131	XP130	XP129	XP128
Spindle X30-F-ER25	Spindle X30-L-ER25	Spindle X30-F-QTC-HSK32	Spindle X30-L-QTC-HSK32
2x dowel pin 6x12	2x dowel pin 6x12	Lubricating metal paste for tool clamp	Lubricating metal paste for tool clamp
4x M8x25	4x M8x25	2x dowel pin 6x12	2x dowel pin 6x12
ER25 Mini clamping nut	ER25 Mini clamping nut	4x M8x25	4x M8x25
Hook wrench shaft	Hook wrench shaft		
Hook wrench clamping nut Mutter	Hook wrench clamping nut		

XP093	XP094	XP100	XP101
Spindle X30-F-SK30	Spindle X30-L-SK30	Spindle X30-F-HSK-E40	Spindle X30-L-HSK-E40
Lubricating metal paste for tool clamp	Lubricating metal paste for tool clamp	Lubricating metal paste for tool clamp	Lubricating metal paste for tool clamp
2x dowel pin 6x12	2x dowel pin 6x12	2x dowel pin 6x12	2x dowel pin 6x12
4x M8x25	4x M8x25	4x M8x25	4x M8x25

## 05.3 Installation of the spindle

The installation of the SPINOGY X30 spindle may only be carried out by qualified staff. During all work, the locally applicable occupational safety and accident prevention regulations as well as internal company regulations must be observed and complied with. Suitable tools must be used for the installation.



### **WARNING: Unauthorized staff**

Unauthorized staff is unaware of the hazards in their work area. Failure to comply with the person- nel requirement can result in serious injury or even death.

**WARNING: Falling parts**

During installation, components may fall, resulting in serious injury and property damage. It is recommended to work at least in pairs and to wear suitable protective equipment and use appropriate tools.

The spindle is to be installed in the following steps:

01. The sealing plugs protecting the pneumatic connections and coolant connections from contamination and damage during transport must be removed.
02. The spindle must be fastened to the machine (chapter 05.4. Mounting the spindle).
03. The motor and, if necessary, the sensor connection line must be plugged onto the connections provided for this purpose and locked (Chapter 5.5 Pin assignment).
04. The coolant connections are to be connected with corresponding hoses (Chapter 5.6 Coolant connections).
05. The pneumatic connections must be connected to the corresponding hoses (Chapter 5.7 Pneumatic connection).

## 05.4 Assembly of the spindle

The spindle has a screw connection option from the front or rear (For dimensions, see chapter 04.2).

In case the spindle is screwed from the front, the screws on the z-axis can be screwed in so far that the spindle can be hooked into the holes provided for this purpose. Nevertheless, the spindle must be fixed manually to prevent it from falling down. Then press the spindle down and tighten the screws (see figure on the right side). For screwing from the front, a screwdriver with a ball socket similar to HAZET is recommended.

Tighten the screws (front or rear) with a torque of 18 to 20 Nm, considering the screw-in depth and plate material.

For the alignment of the spindle, pinholes (opposite side with tolerance H7) for 6x12 dowel pins are provided according to chapter 04.2 (use screw lock). Always check the alignment to the machine table after each assembly.

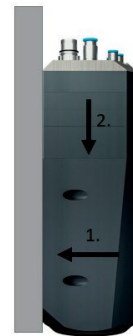

## 05.5 Pin allocations

The X30 has a motor plug and, if necessary, a sensor plug.

### Liquid cooled

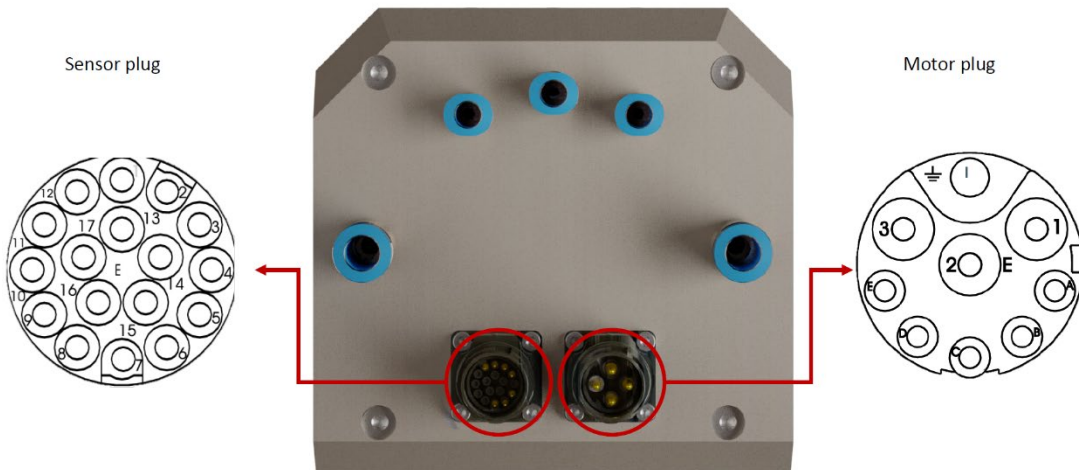

### Air cooled

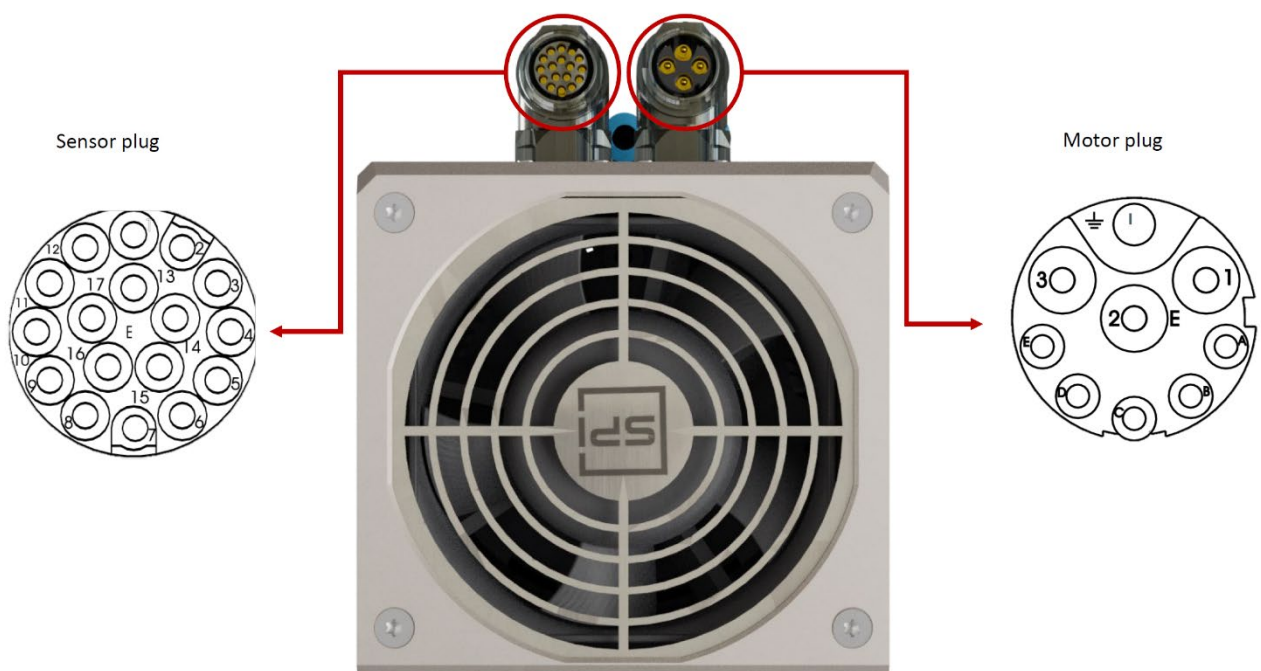

The plug on the connection cable (available pre-assembled from SPINOGY) for the motor or the sensor system is to be plugged onto the corresponding connection on the spindle (see picture) with the arrow pointing forwards and pushed on as far as it will go. Then turn the quick-release fastener on the connector in the "close" direction to prevent the connector from slipping off.

The pin assignment is as follows and refers to the connection lines of SPINOGY.

**Motor plug (cable orange) for XP093, XP100, XP129, XP131 (liquid cooled)**

Function	Option no.:	Plug side (spindle)	Cable side
Phase U		1	U/L1
Phase V		2	V/L2
Phase W		3	W/L3
PE Protective earth			Yellow/Green
PTC /PTC-cascade or PT100 motor+	CG015, CG017, CG018, CG019	A	Brown
PTC /PTC-cascade or PT100 Motor-		B	White
-		D	
-		E	

**Motor plug (cable orange) for XP094, XP101, XP128, XP130 (air cooled)**

Function	Option no.:	Plug side (spindle)	Cable side
Phase U		1	U/L1
Phase V		2	V/L2
Phase W		3	W/L3
PE Protective earth			Yellow/Green
PTC /PTC-cascade or PT100 Motor+	CG015, CG017, CG018, CG019	A	5
PTC /PTC-cascade or PT100 Motor-		B	6
Fan 0 V		D	7
Fan 24 V		E	8

All basic versions of the spindles are equipped with a PTC at the coil end. In case two or three PTCs are installed in the spindle (option no.: CG015, CG017, CG019), these are connected in series as a cascade, so that no further slot is necessary.

**Sensor plug (cable green)**

FUNCTION	OPTION NO.:	PLUG SIDE (SPINDLE)	CABLE SIDE	
			FD 798CP 8x2x0,18	FD 798CP S1 16G
0 V (Ground)	XP005, XP006, XP007, XP008, CG049, CG020, CG021, CG022, CG104, CG136, CG137, CG138	1	White	Brown/Blue
24 V (Sensors)	XP005, XP006, XP007, XP008, CG049, CG104	2	Grey	Brown/Red
Clamped without tool S1	XP005, XP006, XP007, XP008	3	Purple	Brown/Yellow
Clamped with tool S2		4	Blue	Brown/Grey
Ejection position S3		5	Yellow	Green/Red
PT100 bearing front V+	CG014	6	Green	Green/Black
PT100 bearing front V-		7	Orange	Blue
PT100 bearing back H+	CG016	8	Black	Grey
PT100 bearing back H-		9	Red	White/Yellow
Encoder PZ	CG022, CG138	10	Brown	White/Black
Encoder NZ		11	Yellow/White	Red
Signal rotation speed or Encoder PA	XP005, XP006, XP007, XP008, CG049, CG020, CG021, CG022, CG104, CG136, CG137, CG138	12	Orange/White	Orange
Encoder NA	CG020, CG021, CG022, CG136, CG137, CG138	13	Red/White	Brown
Encoder PB	CG021, CG022, CG137, CG138	14	Brown/White	Black
Encoder NB		15	Black/White	Green
Encoder Vcc (5 V)	CG020, CG021, CG022, CG136, CG137, CG138	16	Green/White	Yellow

Strain relief shall be provided to prevent breakaway.

## 05.6 Coolant connections

Spindles with liquid cooling (item No.: XP093, XP100, XP129, XP131) have a push-in fitting for the coolant inlet and one for the coolant outlet on the top of the spindle.

The designation of the coolant connections can be taken from the following chart:

DESIGNATION	DESCRIPTION	EXTERNAL DIAMETER HOSE
$W_{in}$	Coolant inlet	8 mm
$W_{out}$	Coolant outlet	8 mm

Strain relief shall be provided to prevent breakaway.

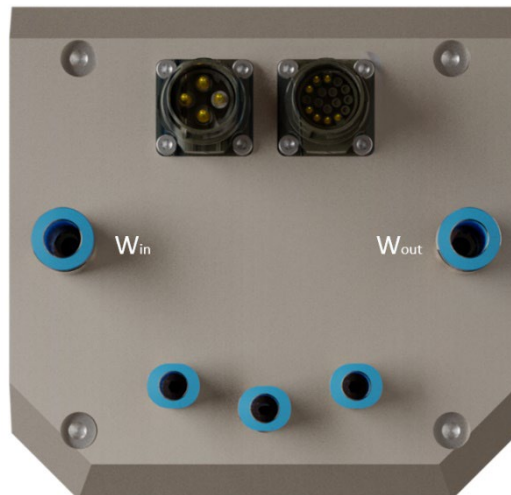

## 05.7 Pneumatic wiring

The spindles with automatic tool change (XP093, XP094, XP100, XP101) each have three pneumatic connections. On the liquid-cooled spindles (XP093, XP100), the connections are located at the top of the housing cover

On the air-cooled spindles (XP094, XP101), the connections are located on the front of the spindle.

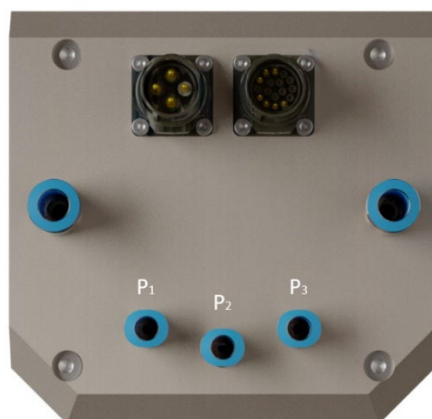

The pneumatic connection can be taken from the following table:

DESIGNATION	DESCRIPTION	PRESSURE LEVEL	EXTERNAL DIAMETER HOSE
P1	Release pressure for unclamping tool	6 to 10 bar	6 mm
P2	Taper blow for cleaning the taper	1 to 1,5 bar	6 mm
P3	Pneumatic piston return for clamping the tool	minimum 3 bar	6 mm

It must be ensured that venting during release (pressurization of P1) takes place via port P3 and venting during clamping (pressurization of P3) via port P1. A suitable valve must be used. It is also recommended to use a valve that permanently pressurizes inlet P3 when de-energized.

The release pressure and taper blow must be switched with a time delay, otherwise damage may occur inside the spindle. When releasing a tool, the release pressure must be switched on first and the taper blow approx. 0.75 seconds later. When clamping a new tool, the taper blow must be deactivated first.

When using the Xcontrol-P (available from SPINOGY), this connection is already provided. Only the connections P1 to P3 must be connected to the spindle according to the designation.

The hoses from pneumatic valves to the spindle must be kept as short as possible.



# 06 Commissioning



## **WARNING: Machinery Directive 2006/42/EC must be applied**

Before placing on the market or commissioning a machine into the spindle is installed, the manufacturer or the operator must ensure that the Machinery Directive 2006/42/EC applies. For this purpose, reference is made to Article 5 of the currently valid Machine Guideline.

Furthermore, it must be checked whether other regulations or directives apply and must be complied with.

## 06.1 Commissioning for regular use

When commissioning in regular operation, check the following points before starting work:

01. Is the tool correctly clamped, or is there a tool holder in the spindle?
02. Is the tool used designed and balanced for the maximum speed?
03. Is the tool not engaged and the spindle far enough away from the workpiece or the machine table?
04. Is the fan or the cooling unit switched on?
05. Is the air compressor switched on and does the system pressure correspond to the required pressure level?
06. Are all sensors ready for operation and do not show any errors?
07. Is the spindle shaft rotating in the correct direction? The usual direction of rotation is shown in the following figure, but must always be checked for each tool and its use.

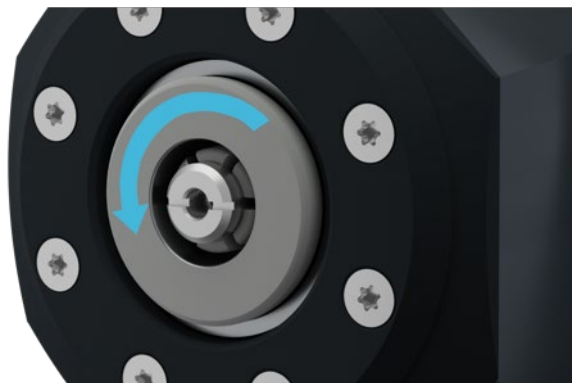

## 06.2 Warm-up run and grease distribution run

Depending on the time of non-use, storage time and position or mounting position, a corresponding warm-up run or grease distribution run must be carried out with the spindle. This ensures consistent bearing lubrication, which results in the bearing temperature being low and thus increases the grease and bearing service life.

The following table compares position or mounting position with downtime or running-in time. In this way, the appropriate running-in program can be selected for the X30.

	IDLE-TIME / STOCKING TIME	
Storage resp. Mounting position	> 2h ≤ 1 week	> 1 week
Vertical	Warm-up run	Grease distribution run
Horizontal	Grease distribution run	Grease distribution run

In general, during the run-in programs, the speed is increased in partial steps at certain time intervals until the nominal speed of the spindle is reached. The nominal speed of all X30 spindles with a 2-pole motor is 24.000 rpm.

### 1. Warm-up run

Warm-up takes place in partial steps of five minutes. The speed is increased up to 24.000 rpm in 25% steps. The respective speed-time intervals can be taken from the following diagram.

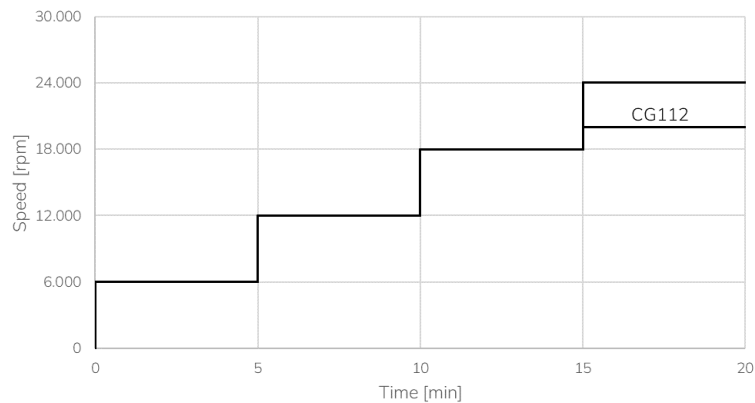

### 2. Grease distribution run

The grease distribution run consists of two phases. The first phase comprises short intervals at reduced speed, the second phase long intervals at nominal and maximum speed. In phase 1, the speed is increased in 33% increments up to nominal speed. Each interval consists of four runs at one minute, with a two-minute break in between. The respective speed-time intervals can be taken from the following diagram.

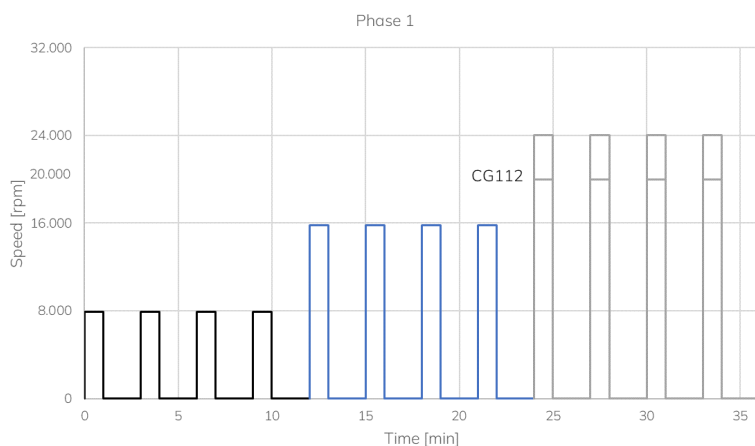

Period 2 follows on directly from period 1. The spindle is accelerated to the nominal speed of 24.000 rpm and operated at this speed for 30 minutes. This is followed by a five-minute break. After this, the maximum speed of the spindle is approached and held for 30 minutes. The maximum speed with which the spindle is equipped can be taken from the respective option no. (e.g. a spindle with option no.: CG006 has a maximum speed of 30.000 rpm).

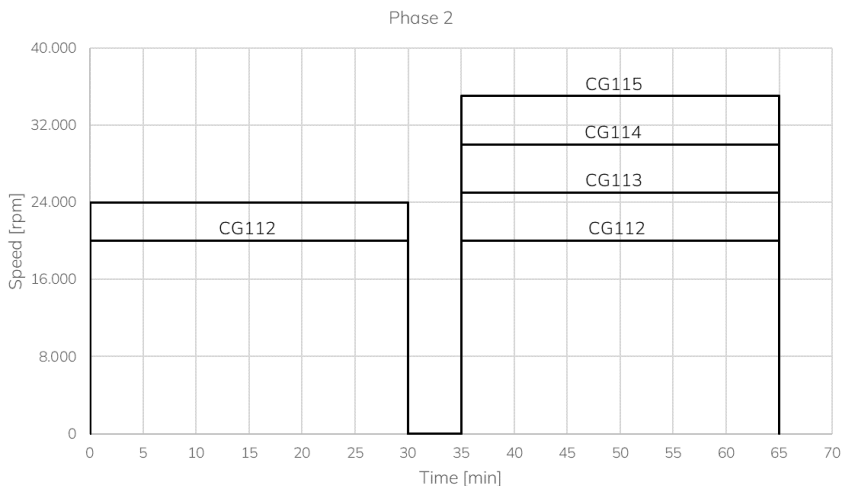

The following points must always be observed during the run-in procedures:

- Avoid external burdens
- Acceleration to partial speed in 20 seconds
- Check the temperature and the noise level (if the housing temperature exceeds 50°C or if the noise level is extremely high, interrupt the respective run-in program and restart it from the beginning after a rest period)
- High quietness and constant temperatures indicate a completed grease distribution run

The following [Link](#) contains a macro for the grease distribution run.

### 06.3 Manual tool change

For the spindles in the ER20 or ER25 version (item No.: XP001, XP002, XP003, XP004), a mini clamping nut (included in the scope of delivery) is recommended for clamping the tool. To clamp the tool, hold the shaft against the tool with the hook wrench included in the scope of delivery (ER20: wrench size 21, ER25: width across flats 27) and tighten it with the wrench for the clamping nut included in the scope of delivery.

The following tightening torques (for mini clamping nuts) must be observed:

TOOL INTERFACE	CLAMPING DIAMETER [mm]	TIGHTENING TORQUE [Nm]
ER25	1,0 – 3,5	24
	4,0 – 4,5	32
	5,0 – 7,5	32
	8,0 – 17,0	32



**WARNING: Do not change the tool until the shaft is stationary**

Before changing tools manually, always make sure that the spindle shaft is stationary. Otherwise serious injuries may occur.



**NOTE: Tightening torques must be observed**

The specified torques must be observed, as otherwise damage to the clamping key may occur.

In addition, excessive tightening can negatively affect the circular runout, and the resulting imbalance can cause damage to the spindle bearings.

## 06.4 Semi-automatic tool change

At the semi-automatic tool change it is not the tool that is changed by hand, but the tool holder.

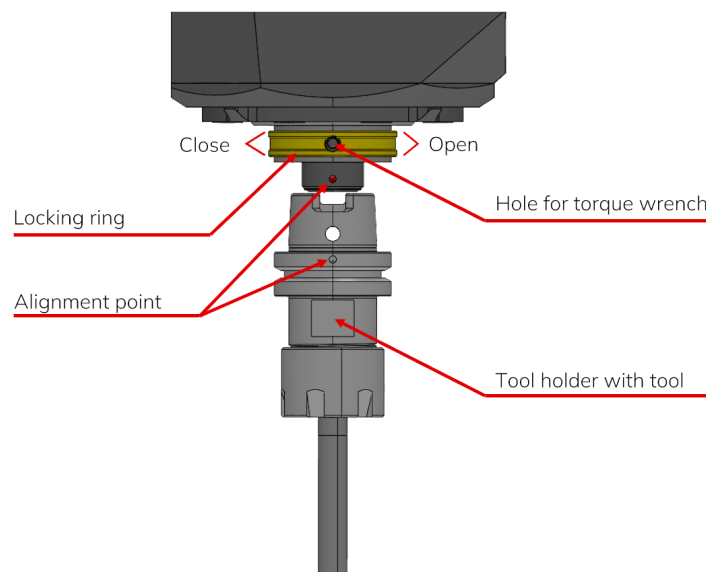

Referring to the figure, the clamping of the tool is carried out in the following steps:

01. Open the hole for the torque wrench by turning the locking ring counterclockwise.
02. Align the hole on the tool holder with the red dot on the spindle clamp.
03. Insert the tool holder into the shaft with one hand until stop and fix it in place with the other hand.
04. Insert the torque wrench (3 Nm tightening torque must be observed, therefore use SPINOGY torque wrench) into the hole with the other hand.
05. Turn the torque wrench clockwise until it triggers.
06. Pull out the torque wrench again.
07. Close the hole for the torque wrench again by turning the locking ring clockwise.

The release of the tool is performed in the following steps:

01. Open the hole for the torque wrench by turning the locking ring counterclockwise.
02. Fix the tool holder with one hand.
03. Insert the torque wrench into the hole with the other hand.
04. Turn the torque wrench counterclockwise until there is a gap between the face contact of the spindle shaft and the face contact of the tool holder (see figure). A little more force is required for the last turn until the gap appears. But do not overtighten the torque wrench.
05. Pull out the torque wrench.
06. Pull the tool holder out of the shaft.

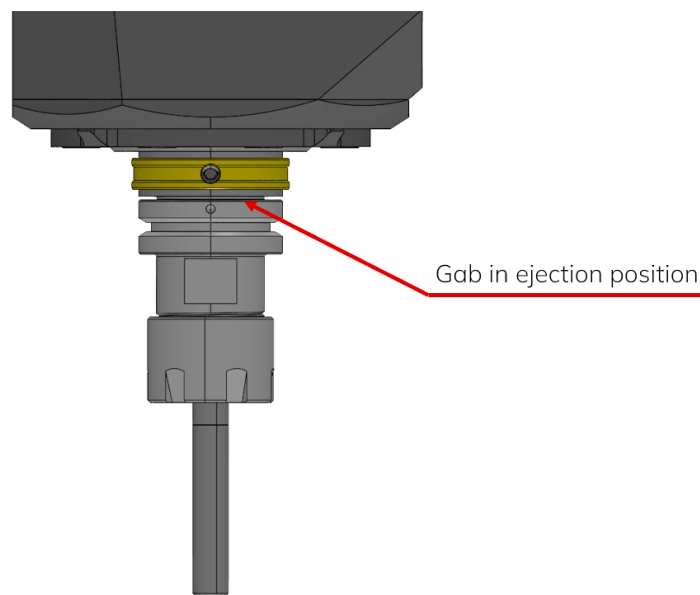

Tool unclamped

For a more detailed explanation of the tool change with a X22-QTC see the video via the [Link](#).

## 06.5 Automatic tool change

In order to carry out a problem-free tool change and to avoid collisions, the following steps must be observed:

01. Switch off spindle or issue control command for spindle stop (M05) and ensure that the spindle shaft comes to a stop. This can be done either by evaluating the speed sensor (for item No.: CG020, CG021, CG022, CG049) or by a sufficiently long waiting time after the stop command. Please note that the time until the spindle shaft stops depends on the inverter programming as well as on the speed and the tool weight. If no speed sensor is available for evaluation, the actual time until the spindle shaft comes to a standstill must be checked in each individual case.
02. Move Z-axis to flight level.
03. Move X-Y position to the position of the empty tool location.
04. Lower the Z-axis at rapid traverse to the safety height above the tool magazine. Select the safety height according to the maximum tool length.
05. Lower the Z-axis to the ejection height with reduced feed.
06. Select the ejection height so that the tool holder can be ejected at least 1 mm in axial direction.
07. Pressurize port P1 and vent port P3 (see chapter 5.7 Pneumatic connection) to eject the tool.
08. Interrogation of the clamping position sensor (see chapter 6.5) to ensure that the tool is correctly ejected.
09. Move Z-axis with reduced feed to safety height.
10. Move to the X-Y position of the desired tool location.
11. If necessary, lower the Z-axis at rapid crossbar to the safety height above the tool magazine.
12. Lower the Z-axis to the feed-in height with reduced feed.
13. The infeed height results as follows: Due to the design, the tool holder is moved out 0.4 mm - 0.6 mm from the face contact of the spindle shaft during tool change, so that the clamping system can safely release the tool holder. This stroke must be observed when approaching the infeed height in order to avoid damage to the clamping system. Accordingly, the infeed height corresponds to the height at which the tool holder axially touches the tool magazine minus the described distance of 0.4 mm - 0.6 mm.
14. Pressurize port P3 and vent port P1 (see chapter 5.7 Pneumatic connection) to retract the tool.
15. Interrogation of the clamping position sensor (see chapter 6.5) to ensure that the tool is correctly drawn in.
16. Move Z-axis to safety height with reduced feed.
17. Continue processing.



**NOTE: Never operate spindles without tool holder**

Spindles with automatic tool change must never be operated without the tool clamped, as this can cause considerable damage to the clamping system.

## 06.6 Monitoring of the tool clamping system

The X30 with automatic tool change (XP093, XP094, XP100, XP101) have a clamping position and piston position monitoring system. This permanently monitors the position of the clamping system and the piston for release. It ensures that spindle rotation is prevented when the tool holder is not inserted. It is advised to connect the sensor monitoring to prevent damage to the clamping system.

Monitoring takes place via three sensors:

- S1 clamped without tool,
- S2 clamped with tool,
- S3 eject position.

The following table describes the switching point evaluation (0: 0 V level, 1: 24 V level):

	S1	S2	S3
<b>Not ready to operate</b>	1	1	1
<b>Tool clamped + piston returned</b>	0	1	1
<b>Failure</b>	0	0	1
<b>Tool released (piston extended)</b>	0	0	0
<b>Overlaps: clamped without tool + unclamped (piston extended)</b>	1	0	0
<b>Overlaps: clamped without tool + piston extended Clamped with tool + piston extended</b>	1	1	0
<b>Clamped without tool + piston returned</b>	1	0	1
<b>Clamped with tool + piston extended</b>	0	1	0

If option CG037 (Without clamping position monitoring) is selected, only whether the piston is retracted is monitored. Therefore, it is expressly pointed out that in this case it must be checked in another way whether the tool holder has been correctly retracted by the clamping system. A measuring of the tool length after each tool change is for example an opportunity to prove if the tool is clamped correctly. An incorrectly retracted tool can cause considerable damage to the clamping system of the spindle.

# 07 Maintenance

## 07.1 Spindle bearings

The spindle bearings are lubricated for life and are maintenance-free. They must be regreased or replaced after an operating time of 2000 hours at the earliest.

To replace or regrease the spindle bearings, send the spindle to SPINOGY for maintenance.



**NOTE: Do not re-lubricate or clean independently**

The spindle bearings must not be re-lubricated or brought into contact with greases, oils or cleaning agents. Any contamination of the bearings drastically reduces the service life. For maintenance of the spindle bearings, the spindle must be sent to SPINOGY.

## 07.2 Maintenance after initial commissioning

After the first five hours of running time of the spindle (this concerns the initial commissioning or new installation after machine modification), all screws for fastening the spindle must be re-tightened with the appropriate torque (chapter 5.4). The motor and sensor connection line, as well as the coolant connections and pneumatic connections, must be checked for tightness.

## 07.3 Daily cleaning

To ensure safe and accurate operation of the spindle, clean the spindle daily before each use. Always use a clean cloth or soft brush to clean the spindle. Regarding the product X30 with automatic tool change, the tool holders and the taper must be cleaned of contamination.

Care of air-cooled spindles by cleaning the protective grille of the fan and the cooling air outlet area of chips, dust and other contaminants. Provide additional suction in case of excessive contamination.



**NOTE: Do not clean the spindle with compressed air**

The spindle must not be cleaned with compressed air under any circumstances. Otherwise, small dust particles may reach the spindle bearings. Any contamination of the bearings drastically reduces the service life.

## 07.4 Monthly maintenance

Every month, all screws for fastening the spindle must be re-tightened with the appropriate torque (chapter 5.4). The motor and sensor connection lines as well as the coolant connections and pneumatic connections must be checked for tightness. If the spindle is not used for a longer period, the shaft must be rotated manually 10 to 15 times per month and then operated for 10 minutes with the tool inserted at a maximum speed of 10,000 rpm (if the spindle is put back into operation after a longer standstill period, a grease distribution run must be carried out).

Information on the storage conditions of the can be found in chapter 3.3.

## 07.5 Re-lubricate HSK- and SK-clamp

The clamps of the X30 with semi-automatic and automatic tool change must be re-lubricated after 500,000 load cycles. A corresponding lubricating metal paste is included in the scope of delivery for this purpose.



## 07.6 Cleaning of the filter mat

If the filter mat option has been selected for an air-cooled spindle, it must be cleaned at regular intervals. The interval depends on the frequency of use and the material processed. In case of milling wood or other materials that produce fine dust the filter mat must be cleaned more frequently.

For this the four screws marked in the following picture must be unscrewed with a torx screwdriver and the housing cover must be removed



Under the housing cover is a package of a fan grid, the filter mat and a bracket for the filter. This must also be removed. Then the filter mat can be vacuumed or blown off.

After cleaning the package (bracket, filter mat, fan grid) must be reassembled with the housing cover in the same sequence.

The four screws must be tightened with 5 Nm.

## 07.7 Maintenance and spare parts

Maintenance work may only be carried out by qualified and trained personnel. If spare parts are required, SPINOGY must be contacted. For the replacement of wear parts the spindle must be opened, this may only be carried out by SPINOGY. For more information, see chapter 9.1.

# 08 Disassembly and disposal

## 08.1 Disassembly

The disassembly as well as the decommissioning of the SPINOGY X30 spindle may only be carried out by qualified staff. During all work, the locally applicable occupational safety and accident prevention regulations as well as internal company regulations must be observed and complied with. Suitable tools must be used for disassembly.



### **WARNING: Unauthorized staff**

Unauthorized employees are not aware of the hazards in the respective work area. Failure to comply with the personnel requisition can result in serious injury or even death.



### **WARNING: Falling components**

During disassembly, components may fall, causing serious injury and property damage. It is recommended to work at least in pairs and to wear suitable protective equipment and use suitable tools.

The spindle is to be put out of operation in the following steps:

01. Stop the spindle and make sure that the shaft is stationary.
02. Eject the tool holder via pneumatic actuation, as otherwise serious injuries may be caused by the tool during disassembly. This step is only to be performed on a spindle with automatic tool change. Removal of the tool on a spindle with manual tool change is only carried out after step 3.
03. Take the machine or the plant out of operation. For this purpose:
  - a. Make sure that there is no tool holder in the spindle. (Applies only to spindles with semi-automatic and automatic tool change).
  - b. Actuate the emergency stop of the machine or system.
  - c. Set the main switch of the machine or system to "0" or "Off".
  - d. Secure the machine or system against unauthorized restarting.
  - e. Disconnect the machine or system from the electrical network. To do this, physically disconnect the power supply lines and discharge any stored residual energy.
04. Remove the tool from the spindle. Otherwise, serious injuries may be caused by the tool during disassembly. This step is only to be carried out for spindles with manual tool change. For spindles with semi-automatic and automatic tool change, this is done in step 1.
05. Cooling units must be switched off (only for spindles with liquid cooling).
06. Make sure that no compressed air is applied to the spindle.
07. Coolant (only for spindles with liquid cooling) and pneumatic hoses (only for spindles with automatic tool change) must be removed. To accomplish this, press the blue ring on the respective connection on the spindle to the rear (step 1) and pull the hose out to the front (step 2).

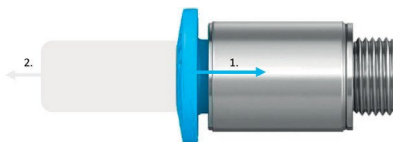

08. All cables (motor cable and, if applicable, sensor cable) must be removed. To do this, the quick-release fastener of the cable plug must be turned in the "open" direction and the plug pulled off upwards.
09. Remove operating and auxiliary materials as well as residual processing materials.
10. The four screws need to be loosened (front or rear). In case the spindle is screwed from the front, the screws only have to be loosened and not completely unscrewed. Then the spindle can be lifted and removed. In case the spindle is screwed

from the rear, the screws must be unscrewed completely. The spindle must be fixed with the hands at all times to prevent it from slipping.

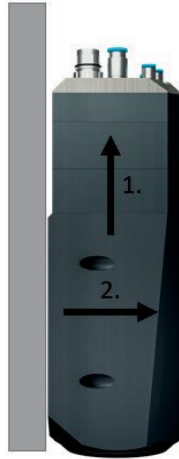

If there are any ambiguities or the disassembly instructions have not been understood or not fully understood, SPINOGY is to be contacted.

## 8.2 Disposal

The disposal of the spindle, any accessories and the packaging must be carried out in accordance with the relevant laws and regulations of the respective country. If in doubt, contact the relevant local authority or a specialist disposal company. Depending on the material, the individual components should preferably be recycled. The spindle consists mainly of recyclable materials such as aluminum, steel and copper. Disposal with domestic waste or similar facilities for the collection of municipal waste is not permitted.

After consulting SPINOGY the spindle can be returned directly to the manufacturer. In this case, a disposal fee may be charged by the manufacturer.

# 09 Service and repair

## 09.1 Service and repair authorized users

The opening and repair of the spindle may be carried out only by SPINOGY, since among other things special tools are used and only then a perfect function can be guaranteed. If unauthorized repairs are carried out, any warranty and guarantee claim expires and SPINOGY is not liable for any resulting damage to property or personal injury.



**WARNING: Repairs by operators or third parties are not permitted**

Unauthorized repairs carried out by the operator or third parties can result in the product not being in perfect condition afterwards, which can lead to property damage and, in the worst case, serious injury or even death.

In case that the X30 has to be sent in for repair, it is possible to obtain a spindle from SPINOGY on a loan basis for the transition period. In this case, SPINOGY must be contacted. It should be noted that the contingent of loan spindles is limited, and the customer has no right to a loan spindle.

## 9.2 Troubleshooting

Using the following chart, possible malfunctions and errors can be recognized and eliminated. In case of ambiguities or deviations of the malfunction, SPINOGY must be contacted immediately. The general safety instructions from chapter 2 apply. Troubleshooting may only be carried out by trained, instructed and qualified personnel.

ERROR	POSSIBLE CAUSES	POSSIBLE SOLUTIONS
<b>Spindle does not run</b>	Missing electrical supply	Check if the motor plug (spindle side) is mechanically secured
		Check if phases at the frequency inverter are mechanically secured
		Check motor plug for any signs of damage
		Check if machine emergency stop is activated, confirm emergency stop
		Check if reset button is activated
	Frequency inverter error triggering	Confirm error displayed by frequency inverter
	Temperature error	Cool down spindle and confirm error displayed by frequency inverter
		Check cable of temperature sensor
Shaft is blocked	Spindle must be sent in for inspection	

FAILURE	POSSIBLE CAUSES	POSSIBLE SOLUTIONS	
<b>Spindle is noisy</b>	Improper tool	Use balanced tools	
		Check if tool is damaged, if necessary change tool	
	Grease distribution run was not conducted properly (e.g. after a long idle or stocking time)	Do grease distribution run	
	Tool holder clamped incorrectly	Check tool holder for correct fit, if necessary clean taper	
	Damaged bearings	Spindle must be sent in for inspection	
<b>Spindle vibrates</b>	Mounting screws loose	Tighten all screws	
	Improper tool	Use balanced tools	
		Check if tool is damaged. If necessary, change tool	
		Overextending tool, use shorter tool	
	Frequency inverter programmed incorrectly	Check if parameters of the frequency inverter are set right	
	Tool holder clamped incorrectly	Check tool holder for correct fit, if necessary clean taper	
	Machining forces too high	Reduce cutting parameters	
Damaged spindle	Spindle must be sent in for inspection		
<b>Spindle is getting hot</b>	Not enough cooling performance (air cooled spindle)	Fan is switched off	
		Fan speed too low	
	Not enough cooling performance (liquid cooled spindle)	Cooling station is switched off	
		Check coolant level	
		Check coolant connection and hose	
		Check if cooling displays an error	
			Increase cooling liquid flow
	Grease distribution run was not conducted properly (e.g. after a long idle or stocking time)	Do grease distribution run	
	Ambient temperature too high	Use a fan in addition for cooling the housing	
	Frequency inverter programmed incorrectly	Check if parameters of the frequency inverter are set right	

FAILURE	POSSIBLE CAUSES	POSSIBLE SOLUTIONS
<b>Tool is not properly ejected</b>	Pressure level too low for unclamping the tool	Set required pressure level chapter 5.7)
	Nominal flow of the pneumatic valve too low	Use pneumatic valve with a nominal flow of minimum 150 l/min
	Pressure built-up of piston unit too low	Use pneumatic valve with a nominal flow of minimum 150 l/min
		Use short pneumatic hose
	Pneumatic valve or hoses dirty	Clean valves and hoses
	Venting does not work properly	Check venting via connection P3
Piston unit is leaking	Spindle must be sent in for inspection	
<b>Tool is not clamped properly</b>	Pressure level for clamping too low	Set required pressure level
	Nominal flow of the pneumatic valve too low	Use pneumatic valve with a nominal flow of minimum 150 l/min
	Pressure built-up of piston unit too low	Use pneumatic valve with a nominal flow of minimum 150 l/min
		Use short pneumatic hose
	Contaminated taper	Clean taper
	Pneumatic valve or hoses dirty	Clean valves and hoses
	Venting does not work properly	Check venting via connection P1
	Tightening bolt incorrect or faulty	Replace tightening bolt
	Piston unit is leaking	Spindle must be sent in for inspection
<b>No sensor signal</b>	No connection to sensor	Check if the sensor plug (spindle side) is mechanically secured
	Sensor plug has a cable break	Change cable
	Cable break in the spindle	Spindle must be sent in for inspection
	Damaged sensor	Spindle must be sent in for inspection
<b>Spindle is leaking</b>	Damaged seal	Spindle must be sent in for inspection
<b>Fan speed decreases (spindle with air cooling)</b>	Fan is contaminated	Clean fan
	Voltage drops due to electromagnetic interferences	Use two different sockets for power supply off and the frequency inverter
	Damaged fan	Spindle must be sent in for inspection

# 10 Warranty

SPINOGY warrants the product against material defects excluding further claims, considering the following points:

01. The warranty period from the date of delivery is 24 months in accordance with statutory provisions.
02. In case of justified complaints of the goods, recognized by SPINOGY, which had their cause probably before the passage of risk of the goods - this concerns in particular the defective function, defects of the external condition or the delivery of a wrong product - According to the German Civil Code (called "BGB" = Bürgerliches Gesetzbuch") Paragraph § 439 (passage 1) you can choose between two options: There is the option to have the defect repaired free of charge by SPINOGY and there is the other option to have it replaced by a defect-free product. The determination of above-mentioned defects at the products must be announced immediately to SPINOGY by writing or documenting the defects visually. The claim of the guarantee presupposes that SPINOGY receives the possibility for the examination of the guarantee case, even if this requires to send in the product.
03. The claim for rectification of defects is not applicable if SPINOGY is entitled to refuse the rectification of defects due to legal regulations. This applies in particular in the case that the subsequent improvement is accompanied by disproportionately high costs. In this case, according to German Civil Code (called "BGB" = Bürgerliches Gesetzbuch") Paragraph § 439 (passage 4), the purchaser's right to subsequent performance is limited to the other option.
04. If more than 6 months have passed since the purchase of the product, the obligation to provide proof, is with the customer. The customer has to prove that the defect already existed before delivery. This applies in particular to defects that are not immediately apparent.
05. Any parts or products replaced under warranty shall become the property of SPINOGY, unless SPINOGY expressly waives such right.
06. For all necessary rework and replacement deliveries, the buyer has to set an appropriate period after consulting SPINOGY. If this is not the case, SPINOGY is released from the liability of resulting consequences.
07. If the warranty claim turns out to be legally valid, the costs arising from a rectification or replacement delivery plus the shipping costs are to be paid by SPINOGY. If the customer initiates the inspection of a product delivered by SPINOGY, and it turns out that there is no warranty case, that means, there are no defects to be complained about, or these are based on reasons SPINOGY is not responsible for, a cost lump sum will be charged according to the service and additional services of SPINOGY.
08. No warranty is given by SPINOGY in the following cases:
  - Improper use
  - Incorrect assembly or disassembly by the purchaser or third parties
  - Incorrect commissioning or decommissioning by the purchaser or third parties
  - Unauthorized modifications of the product
  - Usual wear and tear (e.g. spindle bearings)
  - Improper maintenance
  - Incorrect or careless handling
  - Incorrect storage
  - Disregard of the operating instructions
  - Defects the purchaser already knew at the time of the purchase
  - Force majeure
  - Unsuitable operating site
  - Chemical, electrochemical or electrical influences
09. The ordering party shall be entitled to withdraw from the agreement under the legal provisions if SPINOGY - subject to legally specified exceptions - misses a reasonable deadline set for the improvement or delivery of a replacement product. If there is an insignificant defect, the purchaser shall only be entitled to a reduction of the contract price.
10. In case of self-remedy of defects by the purchaser or third parties, SPINOGY is not liable for the resulting consequences. The same applies to changes made, which SPINOGY has not agreed to.
11. SPINOGY reserves the right to make technical changes to the product (e.g. constructive) without prior notification.
12. SPINOGY reserves the right to update the product to the latest state of the art by carrying out repairs.

# 11 Declaration of installation

(According to EC Machinery Directive 2006/42/EC annex II B)

**Original document**

**Manufacturer:**

SPINOGY GmbH  
Brunnenweg 17  
64331 Weiterstadt  
Deutschland

**Authorized to issue documents:**

SPINOGY GmbH  
Brunnenweg 17  
64331 Weiterstadt  
Deutschland

We hereby declare that the following product

<b>Product</b>	High-frequency spindle
<b>Type</b>	X30
<b>Serial number</b>	

complies with the following basic requirements of the guideline machines (2006/42/EC) :  
Annex 1, subchapter 1.1.2, 1.1.3., 1.1.5.,1.3.2.,1.3.4.

The partly completed machine may only be put into operation until it has been determined that the machine into the partly completed machine is to be installed, complies with the purpose of the Machinery Directive (2006/42/EC) and the EC Declaration of Conformity according to Annex II A is available.

The special technical documents belonging to the partly completed machine according to Annex VII Part B have been created and are kept accordingly.

The manufacturer commits to provide the special technical documents according to Annex VII, Part B, for the partly completed machine to individual national authorities in digital form, upon reasonable request.

If the partly completed machine is modified after it has been handed over to the user without our approval, this declaration loses its validity with immediate effect.



Marc Schmidt-Winterstein  
Authorized representative for documentation



**high-performance**  
**compact**  
**configurable**



# made in Germany

**SPINOGY GmbH**  
Brunnenweg 17,  
64331 Weiterstadt  
mail@spinogy.de  
+49 6150 / 970 960  
[spinogy.de](http://spinogy.de)

©SPINOGY GmbH

Rev.06//2024